



ETAP 16

October 2016

We are pleased to announce the release of ETAP 16 Power System Design & Operation Software.

ETAP 16.0 Model-Driven Power System Design & Operations Software expands on immersive system modeling and comprehensive simulation capabilities.

Upon finishing installation of ETAP 16, a new 48-digit activation code is required to activate and open the application. The activation code is provided on the ETAP 16 installation DVD and via e-mail.

For more information on this new release, please take a few moments to review the information below.

Multi-Language Edition

- English
- Spanish
- Portuguese
- Russian
- Chinese
- Japanese
- Korean
- Italian*
- Turkish*

**Output Reports Only*

Major Enhancements & Features

User-Defined Dynamic Models

- Blazing performance up to 50 X faster
- Enhanced Result Visualization with Multi-Scope
- Math functions with Multiple Inputs
- Enhanced Timer Integration
- Customizable Events for Test Routines
- New Generic Load Test Routines
- Go-To blocks for Internal and External UDM Communication
- MIMO User-Defined Function Blocks using C# Script

Cable Capacity Sizing - IEC 60092

- Size Power Cables based on IEC 60092 Electrical Installation in Ships & Marine Vessels
- Line Conductor Sizing
- Consider Short-Time Duty
- Selectable Annex B for General Installations
- Enhanced Reports and Cable Manager

This document and the information within it are confidential and proprietary to ETAP/Operation Technology, Inc. and may not be modified, copied, published, disclosed, distributed, displayed or exhibited in either electronic or printed formats without the written authorization of ETAP/Operation Technology, Inc., 17 Goodyear, Suite 100, Irvine, CA 92618, USA. © 2016 ETAP/Operation Technology, Inc. All Rights Reserved.

Datablock

- New Intelligent Device Settings Datablock
- Auto-update Device Functions & Settings
- Export One-Lines and Datablock to AutoCAD™ (DXF) Drawing Files

System Elements

- Motor Operated Valve Dynamic Voltage Limits
- Enhanced Overhead Line Impedance Calculations
- Enhanced IEC Fuse Ratings

Short Circuit

- Export Short Circuit Analyzer Results to MS Excel
- User-Defined Fuse Test PF and X/R for Short-Circuit Duty Evaluation

Transient Stability

- Consider MOV Dynamic Voltage Limits
- Enhanced Generator Excitation Systems

Wind Turbine Generator

- New Control Block Test Routines
- New Complex Terminal Voltage Input Blocks
- Complex Terminal Current Output Blocks

Enhanced Modules

- Data Exchange (DataX)
- Underground Raceway Thermal Analysis
- Dynamic Parameter Estimation & Tuning (DPET)

Library Additions

The following protective device manufacturers and models are added to the library.

	MFR	Model
Cable	Indeco	N2XSY
	SolidAl	A2X(FL)2Y

	MFR	Model
Fuse – ANSI (AC)	Edison	TJS
Fuse – ANSI (DC)	Bussmann	FRN-R (10/08)

	MFR	Model
LVCB – ANSI (AC)	Square-D	ECB-G3, ECB-G3 (15A&20A), ECB-G3 (30A), HR, JR, LR
LVCB – ANSI (DC)	Eaton	LG PV, MDL PV

	MFR	Model
LVCB – IEC (AC)	Square-D	HR, JR, LR (400A), LR (600A)

	MFR	Model
TM	Eaton	LG PV, MDL PV
	Siemens	LMD
	Square-D	ECB-G3

	MFR	Model
Relay	ERL Phase Power Tech.	5B3
	GE Multilin	IAC-70A, IAC-70B
	Schweitzer	411L
	Siemens	7PG23-5B3



System Requirements

Operating System (64-bit)

Microsoft® Windows® 10 Pro
Microsoft® Windows® 8 & 8.1 (Standard, Professional)
Microsoft® Windows® 7 (Home Premium, Professional, Ultimate) (SP 1)
Microsoft® Server 2012 & 2012 R2 (Standard)
Microsoft® Server 2008 R2 (Standard) (SP1)

Other Software Requirements

Internet Explorer® 10 or higher (or minimum version level specified by the Operating System)
Microsoft .NET Framework v3.5 (SP1)
Microsoft .NET Framework v4.0
Microsoft .NET Framework v4.5
Microsoft SQL Server Compact 3.5 (SP2)
Microsoft Windows Update (KB2670838)
Microsoft SQL Server 2012 Express LocalDB (x64)
Microsoft SQL Server 2012 Native Client (x64)
Microsoft SQL Management Studio 2012 (x64)

PC Configuration Requirements

64-bit hardware
USB port
Ethernet port w/ network access (if network licensing required)
DVD Drive, 10 to 80 GB hard disk space (based on project size, number of buses)
19" monitors recommended (dual monitors highly recommended)
Recommended display resolution – 1920 X 1080
Recommended display font size – 100% - 125%

Recommended Hardware

100 Bus Projects

Intel Core i5 or better – 2.0 GHz or better (or equivalent)
4 GB RAM

500 Bus Projects

Intel Core i5 or better – 2.0 GHz or better (or equivalent)
8 GB RAM

1,000 Bus Projects

Intel Core i5 or better – 3.0 GHz with Hyper-Threading & high speed bus (or equivalent)
16 GB RAM (high-speed)

10,000 Bus Projects and Higher

Intel Core i7 or better – 3.0 GHz with Hyper-Threading & high speed bus (or equivalent)
32 GB RAM - (high-speed)

This document and the information within it are confidential and proprietary to ETAP/Operation Technology, Inc. and may not be modified, copied, published, disclosed, distributed, displayed or exhibited in either electronic or printed formats without the written authorization of ETAP/Operation Technology, Inc., 17 Goodyear, Suite 100, Irvine, CA 92618, USA. © 2016 ETAP/Operation Technology, Inc. All Rights Reserved.



ETAP 14.1

December 2015

We are pleased to announce the release of ETAP 14.1 Power System Design & Operation Software.

ETAP 14.1 is the latest upgrade to the ETAP 14 series and includes important enhancements based on the industry's latest demands such as multi-language output reports and arc flash labels.

Upon finishing installation of ETAP 14.1, a new 48-digit activation code is required to activate and open the application. The activation code is provided on the ETAP 14.1 installation DVD.

For more information on this new release, please take a few moments to review the information below.

1. New & Enhanced Features

ETAP

- Improved Window 10 Compatibility
- Windows font handling up to 125% magnification
- Refreshed Element Editors & Printing
- Helpline & User Guide revisions
- Enhancements to ETAP License Manager
- Improved Library & Project conversions

Short Circuit

- Short Circuit Analyzer – Ability to save analyzer settings
- Thermal Withstand Duty Evaluation for IEC Standard

Arc Flash

- Arc Flash Analyzer – Enhanced speed & report location viewing capability
- Translated Arc Flash Labels
 - Spanish
 - French
 - Portuguese
 - German
 - Chinese
 - Russian
 - Japanese
 - Korean **NEW**
 - Italian **NEW**

This document and the information within it are confidential and proprietary to ETAP/Operation Technology, Inc. and may not be modified, copied, published, disclosed, distributed, displayed or exhibited in either electronic or printed formats without the written authorization of ETAP/Operation Technology, Inc., 17 Goodyear, Suite 100, Irvine, CA 92618, USA. © 2015 ETAP/Operation Technology, Inc. All Rights Reserved.

Star – Protective Device Coordination

- New Protective Device Settings Reports in Excel format
- Addition of Crystal Reports with support of DC protective devices
- Addition of Excel Brief Reports with automated print fit
- Support of Panel and DC Device Settings in Excel Report
- Addition of Adjacent Bus to Excel Detail Report for sorting by substation
- Addition of more than 60 models for relay and breaker protective devices

Cable Sizing & Derating

- Comply with British Standard 7671:2008 +A3:2015 cable sizing
- Updated IEC 60364-5-52 LV cable sizing standard

Other Modules

- Improved Underground Raceway Systems Alignment Tools
- Transient Stability Plot Enhancements
- Updated Harmonics Alert View
- Translated Study Reports
 - Spanish
 - French
 - Portuguese
 - German
 - Chinese
 - Russian
 - Japanese
 - Korean
 - Italian NEW
- Faster Crystal Report generation speed for device settings reports

2. ETAP Real-Time – New & Enhanced Capabilities

eSCADA

- Multistate element colors & symbols
- General Measurements Alarming
- Enhanced Quick Navigation & Toolbar layout
- Transformer Tap Control
- IEC 61850 - Support up to 125 devices per data collection concentrator
- CSV Driver Communications
- Electrical & Non-Electrical Control Commands
- Real-Time Continuity Coloring

This document and the information within it are confidential and proprietary to ETAP/Operation Technology, Inc. and may not be modified, copied, published, disclosed, distributed, displayed or exhibited in either electronic or printed formats without the written authorization of ETAP/Operation Technology, Inc., 17 Goodyear, Suite 100, Irvine, CA 92618, USA. © 2015 ETAP/Operation Technology, Inc. All Rights Reserved.

Intelligent Load Shedding (ILS)

- Sequence-of-Events Recording
- Event Analyzer

Automatic Generation Control (AGC)

- Generator Maintenance Warning & Alarms
- Fuel Level Monitoring
- Forbidden Operational Areas

Customizable Reports

- Reports Designer
- ETAP SCADA & Web Report Viewer
- Automatic Report Scheduler
- Real-Time & Historical Data Access

Library Additions

The following protective device manufacturers and models are added to the library.

	MFR	Model
LVCB – ANSI (AC)	Federal Pacific	XF
	Westinghouse	BJ, BJH

	MFR	Model
LVCB – IEC (AC)	L&T	DM 100, DM 16, DM 160, DM 250, DM 400

	MFR	Model
TM	Federal Pacific	XF
	Westinghouse	BJ / BJH

	MFR	Model
Relay	ABB	MCU, REF 620, REF 630, REG 630, REM 620, REM 30, RET 620, RET 630
	Schneider Electric	P111

	MFR	Model
MCP	L&T	DM



System Requirements

Operating System (64-bit)

Microsoft® Windows® 10 Pro
Microsoft® Windows® 8 & 8.1 (Standard, Professional)
Microsoft® Windows® 7 (Home Premium, Professional, Ultimate) (SP 1)
Microsoft® Server 2012 & 2012 R2 (Standard)
Microsoft® Server 2008 R2 (Standard) (SP1)

Other Software Requirements

Internet Explorer® 10 or higher (or minimum version level specified by the Operating System)
Microsoft .NET Framework v3.5 (SP1)
Microsoft .NET Framework v4.0
Microsoft .NET Framework v4.5
Microsoft SQL Server Compact 3.5 (SP2)
Microsoft Windows Update (KB2670838)
Microsoft SQL Server 2012 Express (x64)
Microsoft SQL Server 2012 Express LocalDB (x64)
Microsoft SQL Server 2012 Native Client (x64)
Microsoft SQL Management Studio 2012 (x64)

PC Configuration Requirements

64-bit hardware
USB port
Ethernet port w/ network access (if network licensing required)
DVD Drive, 10 to 80 GB hard disk space (based on project size, number of buses)
19" monitors recommended (dual monitors highly recommended)
Recommended display resolution -1280 X 1024
Recommended display font size – 100% - 125%

Recommended Hardware

100 Bus Projects

Intel Core i5 or better – 2.0 GHz or better (or equivalent)
4 GB RAM

500 Bus Projects

Intel Core i5 or better – 2.0 GHz or better (or equivalent)
8 GB RAM

1,000 Bus Projects

Intel Core i5 or better – 3.0 GHz with Hyper-Threading & high speed bus (or equivalent)
16 GB RAM (high-speed)

10,000 Bus Projects and Higher

Intel Core i5 or better – 3.0 GHz with Hyper-Threading & high speed bus (or equivalent)
32 GB RAM - (high-speed)

This document and the information within it are confidential and proprietary to ETAP/Operation Technology, Inc. and may not be modified, copied, published, disclosed, distributed, displayed or exhibited in either electronic or printed formats without the written authorization of ETAP/Operation Technology, Inc., 17 Goodyear, Suite 100, Irvine, CA 92618, USA. © 2015 ETAP/Operation Technology, Inc. All Rights Reserved.



ETAP 14.0

August 2015

We are pleased to announce the release of ETAP 14 Power System Design & Operation Software.

ETAP 14 delivers unmatched speed, intelligence, and reliability to increase productivity. It offers powerful rule-books, result analyzers, and automated evaluation tools to reduce engineering time, enforce standards, ensure design integrity, and optimize system operation. Gain a competitive edge and accelerate system design and analysis with ETAP.

Upon finishing installation of ETAP 14.0, a new 48-digit activation code is required to activate and open the application. The activation code is provided on the ETAP 14.0 installation DVD.

For more information on this new release, please take a few moments to review the information below.

New Features

- *64-bit architecture*
- *System Manager & Docking*
- *Graphical Contouring based on results*
- *Circuit Tracing*
- *Auto-Build*
- *Datablock*
- *Load Flow Model Validation*
- *Short Circuit Analyzer*

New Analysis Modules

- *Star, Auto-Evaluation*
- *Contingency Analysis*
- *Motor Dynamic Parameter Tuning*
- *IEC 60502*
- *NF C 15-100*

Data Exchange

- *Import from SKM®*
- *Import from EasyPower®*
- *PSS/E®*
- *Aveva Electrical™*
- *SmartPlant® Electrical*
- *EMTP-RV®*
- *PSCAD® / EMTDC®*

Enhanced Modules

- *One-Line Diagram*
- *Theme Manager*
- *Load Flow*
- *Short Circuit*
- *AC/DC Arc Flash Analysis*
- *Star*
- *Transient Stability*

Libraries

- *Quickpick tabular views*
- *Low Voltage Circuit Breakers*
- *Low Voltage Solid State Trip*
- *Relays*
- *Cables*
- *Induction Motors*

Enhanced Elements

- *Relays*
- *LV Circuit Breakers*
- *LV Solid State Trip Units*
- *Induction Motors*
- *Synchronous Motors*
- *Transformers*
- *Cables*

This document and the information within it are confidential and proprietary to ETAP/Operation Technology, Inc. and may not be modified, copied, published, disclosed, distributed, displayed or exhibited in either electronic or printed formats without the written authorization of ETAP/Operation Technology, Inc., 17 Goodyear, Suite 100, Irvine, CA 92618, USA. © 2015 ETAP/Operation Technology, Inc. All Rights Reserved.

1. New Features

ETAP Foundation

- 64-bit architecture
- Local SQL database
- System Manager & Docking

One-Line Diagram

- High-resolution graphics
- Graphical symbol selection
- Graphical contouring based on results
- Circuit Tracing

Auto-Build

Auto Build is an automated and powerful tool for creating and editing the one-line diagram. The rule-based design of Auto-Build can significantly reduce the time spent on creating a one-line.

Features

- Automated creation of one-line without leaving the equipment toolbar
- Quick & Intuitive One-Line Generation
- Automatic Spacing & Alignment Rules
- No Need to Drag, Drop, Locate, and Connect

Datablock

Add component information, input data, and study results in one block to view on the one-line diagram. Datablocks are also fully customizable allowing them to be shown, hidden, arranged, and formatted according to the user's preference. An advantage with using datablocks is showing properties and results from different studies and displaying this information within the same one-line diagram.

Features

- Customize input data & study results
- Display results, tags, and/or properties
- Define templates & share
- Automatically apply templates
- Instant preview of Datablock

Load Flow Model Validation

Identify and alert against modelling issues whether critical, marginal, or informative.

Features

- Causes for Non-Convergence
- Voltage-Stability Considerations
- Excessive Loading and Generation Levels
- Areas with Unacceptable Voltage Values

This document and the information within it are confidential and proprietary to ETAP/Operation Technology, Inc. and may not be modified, copied, published, disclosed, distributed, displayed or exhibited in either electronic or printed formats without the written authorization of ETAP/Operation Technology, Inc., 17 Goodyear, Suite 100, Irvine, CA 92618, USA. © 2015 ETAP/Operation Technology, Inc. All Rights Reserved.

- MW and Mvar Transfer Capability Limits
- Elements with Possible Incorrect Parameters
- Provide Possible Solutions

Short Circuit Analyzer

The short-circuit result analyzer is a powerful tool which allows the filtering and analysis of the short-circuit results of multiple output reports (scenarios) in one glance. The Short Circuit analyzer provides the worst case condition for ANSI and IEC Device Duty calculations.

Features

- Compare & Analyze Study Results
- User-Defined Base-Line / Reference
- Identify Deviations
- Worst Case Scenarios

2. New Modules

Star, Auto-Evaluation

Auto-Evaluation is a STAR mode feature which is designed for automated protection and coordination evaluation of electrical networks with overcurrent protective devices based on rules.

Features

- Automated and intelligent detection of protection zones
- Automated overcurrent Protection and Coordination Evaluation
- Customized evaluation criteria based on Rule Book
- Through-fault current calculation based on ANSI and IEC standards
- Support of standards and industry practice rules
- Evaluation and Fault Current Type selection
- Tabular and graphical display of evaluation results in colorful formats
- Extensive condition messages highlighting the violation of evaluation criteria
- Dynamic capability to correct the violations and update the results
- Easy-to-make reports from graphical snapshots and evaluation tabular sheets

Contingency Analysis

Contingency analysis represents an important tool to study the effect of elements outages in power system security during operation and planning. It investigates, evaluates, filters and prioritizes the impacts on an electric power system whenever typically unplanned problems or outages occur. Evaluate the impact of N-1 and N-2 contingencies, determine system performance indices, and compare results against safe operating limits for each element in the power system based on user-defined component outage and failure scenarios. For accurate results, AC load flow is run for each contingency.

Features

- N-1 and N-2 Contingency Assessment & Ranking
- Multiple Graphical Outage Lists

This document and the information within it are confidential and proprietary to ETAP/Operation Technology, Inc. and may not be modified, copied, published, disclosed, distributed, displayed or exhibited in either electronic or printed formats without the written authorization of ETAP/Operation Technology, Inc., 17 Goodyear, Suite 100, Irvine, CA 92618, USA. © 2015 ETAP/Operation Technology, Inc. All Rights Reserved.

- Fast Screening Method
 - Scan Outage List
 - Identify higher risk contingencies for further evaluation
- Automatic Performance Indices Calculation
 - Bus voltage security
 - Real power flow change
 - Reactive power flow change index
 - Branch overloading index

Motor Dynamic Parameter Tuning

Calculate equivalent circuit parameters for induction machines from nameplate or characteristic data. This calculation is based on a computational intelligence technique, which requires machine nameplate or characteristic data. In general, the estimated model parameters include the resistance and reactance representing the machine stator, rotor and magnetizing branches characteristics. Nonlinear rotor resistance and reactance including stator impedance are introduced in this module to especially match characteristic curves with a belly.

Features

- Non-Linear dynamic circuit-models - MPET
- Include Rotor Core Losses, Rc
- Match actual MFR characteristic curves
- Save estimated results to library

Cable Ampacity and Sizing

Two new standards are supported by ETAP:

- IEC 60502
- NF C 15-100

3. Enhanced Modules

Theme Manager

- User-defined result format
- Display / hide based on
 - Zoom level
 - Equipment type
 - Equipment state
 - Info annotations
 - Study results
 - Datablocks

Star, Protection & Coordination

- Automated and intelligent detection of protection zones
- Automated Overcurrent Protection and Coordination Evaluation
- Standard, industry practice, and user defined rule book for evaluation criteria
- Evaluation and Fault Current Type selection in Study Case
- Tabular and graphical display of evaluation results in Analysis Viewer
- Graphical snapshot and tabular evaluation reports
- Scenario and Study Wizard for automated evaluation of multiple scenarios with single click of a button

Star View TCC

- Enhanced the Time Difference Tool with intelligence to find the min time or go to predefined time-current
- Enhanced the Crosshair Tool to go to predefined time-current point
- Added Screen Capture for direct paste to third party applications
- Added Label Auto Layout for better automated positioning of labels
- Enhanced the AC Device Settings Report
- Added DC Device Settings Report
- Added Panel Device Settings Report

AC / DC Arc Flash Analysis

- Compliance with the latest standards
- New Dedicated AC and DC Arc Flash Modes
- Create and Append TCCs with Energy Curves
- New NFPA 70E 2015 and CSA Z462 Labels
- Enclosure Isolation for Main and Load Protective Devices
- Conductor Orientation & Equipment Configuration
- New Iterative Method Solution for Photovoltaic Array Systems

Transient Stability

- Motor Core Losses
- Non-linear Rotor Saturation Effects
- Match Test Measurement Data / Manufacture Curves
- Automatic Reference-Source Selection, Enhanced
- Exciter Load Current Compensation

License Manager

- Keyless network licensing

4. Data Exchange

Import from SKM[®]

Enhanced SKM import utility that allows for the automatic conversion of projects created in SKM including automatic protective device mapping and TCC import. This data exchange tool allows for direct import of SKM Dapper[®] PTW32 versions 6.0 & 6.5.

Features

- Converts Dapper[®] PTW32 versions 6.0, 6.5, & 7.0
- Import CAPTOR TCCs into STAR
- Automatic, one click conversion of SKM Dapper projects
- One-line diagram layout conversion per the original project drawing
- Support for multiple one-Line drawing into composite networks
- Automatic protective device settings mapping
- Conversion of AC & DC networks

Import from EasyPower[®]

ETAP 14.0 brings a brand new EasyPower import utility that allows for the automatic conversion of projects created in EasyPower ver. 8.0 and 9.0.

Features

- Automatic import of AC elements including all their input data
- Library mapping utility for importing protective device settings for fuses, Low voltage circuit breakers and trip units as well as relays
- Automatic One-Line diagram import to match the original project layout
- Import of EasyPower TCCs into ETAP's Star coordination module

AVEVA Electrical[™] Interface

- Bi-directional data exchange
- Map attributes of AVEVA Electrical with ETAP elements & properties using Universal Mapping

This document and the information within it are confidential and proprietary to ETAP/Operation Technology, Inc. and may not be modified, copied, published, disclosed, distributed, displayed or exhibited in either electronic or printed formats without the written authorization of ETAP/Operation Technology, Inc., 17 Goodyear, Suite 100, Irvine, CA 92618, USA. © 2015 ETAP/Operation Technology, Inc. All Rights Reserved.

SmartPlant® Electrical Interface

- Supports DC elements
- Supports AC composite networks and composite motors
- Enhanced default mapping
- Merge and sync wizard allows the users to review and change each action per element
- Ignore location changes provides the ability to ignore location changes for existing elements in ETAP

EMTP Interface

- Export the ETAP one-line diagram to EMTP-RV®
- Export the ETAP one-line diagram to PSCAD® / EMTDC®

Export to PSS/E®

- Version 30
- Version 32

5. Enhanced Elements

Relays

- Enhanced and redesigned the Current and Voltage Input
- Added Device Parameters of equipment as reference for protection by relay
- Added Base Current as a new multiplier with separate reference for modeling and analysis of modern microprocessor relays
- Redesigned the Output with unlimited interlock
- Added the reference terminal to OCR/OLR tabs as the input reference for functions
- Added Relay preloading factor
- Block TOC by IOC function
 - When checked, the definite delay time of IOC will take over the TOC delay, starting from the IOC pickup and the TOC+IOC will be combined as a single curve in Star View TCC. The Sequence-Of-Operation and Arc Flash will calculate the trip time based on the displayed curve and respective bolted or arcing fault currents.

Cables

- Automatic cable positive sequence impedance calculation
- Automatic cable zero sequence impedance calculation
- Global System Frequency Impedance adjustment
- Cable Constants
- Cable Armor thermal calculation
- Cable Sheath thermal calculation
- Calculations based on BS 5467, BS 7671 & IEC 60364
- Enhanced Cable Reports

Low Voltage Circuit Breaker

- Added LV Circuit Breaker Override in addition to LV Trip Unit Override

This document and the information within it are confidential and proprietary to ETAP/Operation Technology, Inc. and may not be modified, copied, published, disclosed, distributed, displayed or exhibited in either electronic or printed formats without the written authorization of ETAP/Operation Technology, Inc., 17 Goodyear, Suite 100, Irvine, CA 92618, USA. © 2015 ETAP/Operation Technology, Inc. All Rights Reserved.



Transformer

- Added Transformer FLA marker selection for multi-stage kVA/MVA ratings
- Enhanced the Transformer Fault Frequency withstand capability for protection by source and load side devices

Synchronous Generator

- Added Stator & Excitation Damage to Generator Protection

Synchronous Motor

- Enhanced the thermal curve to represent Stator Hot & Cold or acceleration withstand curve

Induction Motor

- Enhanced the thermal curve to represent Stator Hot & Cold or acceleration withstand curve
- Non-linear dynamic circuit models

Fuse & Inline Overload Relay

- Added Library Quickpick in tabular format with sorting and filtering capabilities

Library Additions

The following protective device manufacturers and models are added to the library.

	MFR	Model
LVCB – ANSI (AC)	Allen-Bradley	140M-J8P
	Cutler Hammer	BR, BRH, CH, CHB, DS-206H, GCH, GHB, JL, LGC, LGE, LGH, LGS, MD, MDS, MDSC, MDSY, MDY
	Federal Pacific	HES 100, HES 160, NES 100, NES 102, NES 160, NP632000
	Hyundai	HAT06, HAT08, HAT10, HAT12, HAT16, HAT20, HAT25, HAT32, HAT40, HAT50
	Merlin Gerin	CF-250H, CF-250HC, CF-250L, CF-250LC, CF-250N, CK 1200H (06/89), CK 400H (06/89), CK 400HH (06/89), CK 800H (06/89), CK 800HH (06/89)
	Square-D	MGP36 (600A), MGP36 (800A), NW60H2, NW60H3, NW60L1
	Terasaki	AR208S, AR212H, AR212S, AR216H, AR216S, AR220H, AR220S, AR316H, AR320H, AR325H, AR325S, AR332H, AR332S, AR420H, AR440H, AR440S, AR440SB, AR650S, AR663H, AR663S
	Westinghouse	MDS, MDSC, MDSY, MDY

	MFR	Model
LVCB – ANSI (DC)	Cutler Hammer	JL
	Federal Pacific	HES 100, HES 160, NES 100, NES 102, NES 160
	Secheron	HPB45-81, HPB45-82, HPB60-81, HPB60-82
	Square-D	PCF-DC

	MFR	Model
LVCB – IEC (AC)	ABB	MS132-0.16 - 2.5, MS132-25, MS132-32, MS132-4.0 - 20, S2X 80
	Allen-Bradley	140M-J8P
	Cutler-Hammer	LGC (250A-400A), LGC (630A), LGE (250A-400A), LGE (630A), LGH (250A-400A), LGH (630A), LGS (250A-400A), LGS (630A), MWI608, MWI610, MWI612, MWI616, MWI620, MWI625, MWI632, MWI64N, MWI808, MWI810, MWI812, MWI816, MWI820, MWI825, MWI832, MWI84N, MWI85N, MWI86N, MWIC08, MWIC10, MWIC12, MWIC16, MWIC20, MWIC25, MWIC32, MWIC4N, MWIC5N, MWIC6N, MWN408, MWN410, MWN412, MWN508,

This document and the information within it are confidential and proprietary to ETAP/Operation Technology, Inc. and may not be modified, copied, published, disclosed, distributed, displayed or exhibited in either electronic or printed formats without the written authorization of ETAP/Operation Technology, Inc., 17 Goodyear, Suite 100, Irvine, CA 92618, USA. © 2015 ETAP/Operation Technology, Inc. All Rights Reserved.

		MWN510, MWN512, MWN516, MWN520, MWN608, MWN610, MWN612, MWN616, MWN620
	Hyundai	HAT06, HAT08, HAT10, HAT12, HAT16, HAT20, HAT25, HAT32, HAT40, HAT50
	Merlin Gerin	CF-250H, CF-250L, CF-250N, CM1250H, CM1250N, CM1600H, CM1600N, CM2000H, CM2000N, CM2500H, CM2500N, CM3200H, CM3200N, NS1000 H (E), NS1000 H (M), NS1000 L (E), NS1000 L (M), NS1000 N (E), NS1000 N (M), NS1000b H (M), NS1000b N (M), NS1250 H (E), NS1250 H (M), NS1250 H (M), NS1250 N (E), NS1250 N (E), NS1250 N (M), NS1250 N (M), NS1250b H (M), NS1250b N (M), NS1250H, NS1250N, NS1600 H (E), NS1600 H (M), NS1600 N (E), NS1600 N (M), NS1600b H (M), NS1600b N (M), NS2000 H (M), NS2000 N (M), NS2500 H (M), NS2500 N (M), NS3200 H (M), NS3200 N (M), NS630b H (E), NS630b H (M), NS630b L (E), NS630b L (M), NS630b N (E), NS630b N (M), NS630b R (M), NS800 H (E), NS800 H (M), NS800 L (E), NS800 L (M), NS800 N (E), NS800 N (M), NS800 R (M), NS800b H (M), NS800b N (M)
	Schneider Electric	MVS08-H, MVS08-N, MVS10-H, MVS10-N, MVS12-H, MVS12-N, MVS16-H, MVS16-N, MVS20-H, MVS20-N, MVS25-H, MVS25-N, MVS32-H, MVS32-N, MVS40-H, MVS40-N
	Square-D	NW40bH1, NW40bH2
	Terasaki	AR208S, AR212H, AR212S, AR216HS, AR216S, AR220H, AR220S, AR316H, AR320HS, AR325H, AR325S, AR332H, AR332S, AR420H, AR440H, AR440S, AR440SB, AR650S, AR663H, AR663S, E630-NE, H250-NE, H400-NE, L400-NE, S250-GE, S250-NE, S250-PE, S400-GE, S400-NE, S630-CE, S630-GE, XS800SE

	MFR	Model
LVCB – IEC (DC)	Terasaki	AR208S, AR212H, AR212S, AR216HS, AR216S, AR220H, AR220S, AR316H, AR320HS, AR325H, AR325S, AR332H, AR332S, AR420H, AR440H, AR440S, AR440SB, AR650S, AR663H, AR663S

	MFR	Model
TM	ABB	MS132, S500-B, S500-C, S500-D, S500UC-B, S500UC-B (DC)
	Cutler-Hammer	BR (1P), BR (2P), BR (3P), CH(1P), CH(2P), CH(3P), CHB(1P), CHB(2P), CHB(3P), F, JL, LW, MD

This document and the information within it are confidential and proprietary to ETAP/Operation Technology, Inc. and may not be modified, copied, published, disclosed, distributed, displayed or exhibited in either electronic or printed formats without the written authorization of ETAP/Operation Technology, Inc., 17 Goodyear, Suite 100, Irvine, CA 92618, USA. © 2015 ETAP/Operation Technology, Inc. All Rights Reserved.

	Federal Pacific	NP
	General Electric	TFJ [04], TFK [04], THFK [04], THKM, THMM, TKM, TPMM
	Merlin Gerin	CF-250
	Square-D	LC (Series 3), PC-DC

	MFR	Model
LVSST	ABB	S500-K, S500UC-K (DC), SACE PR113
	Cutler-Hammer	Digitrip 310+ (LG) LSI, Digitrip 310+ (LG) LSIG, H, MDS, MDSG
	Federal Pioneer	SD-3, SD-6, SS-1, SS-2, SS-3, SS-4, SS-5, SS-6
	Hyundai	AOR-1D-GM, AOR-1L-AL, AOR-1L-AM, AOR-1L-AS, AOR-1L-GL, AOR-1L-GM, AOR-1L-GS, AOR-1S-AL, AOR-1S-AS
	Merlin Gerin	ST 215D, ST 308S, ST 318S, ST 408S, ST 408ST, STCM1, STCM2, STCM3, STR 18M
	Schneider Electric	ET2I, ET5S, ET6G
	Siemens	ETU 555 (DG Frame), ETU 555 (FG Frame), ETU 555 (JG Frame), ETU 555 (LG Frame), ETU 555 (MG frame), ETU 555 (NG Frame), ETU 555 (PG Frame)
	SURE TRIP	RMS-2002
	Terasaki	AGR-S, AGR-S (LT Curve), E630-NE (Curve 1-2), E630-NE (Curve 3), E630-NE (Curve 4-6), Microprocessor (630A, 800A), S250-NE (Curve 1-2), S250-NE (Curve 3), S250-NE (Curve 4), S250-NE (Curve 5-7), S400-NE (Curve 1-2), S400-NE (Curve 3), S400-NE (Curve 4), S400-NE (Curve 5-7)
	Utility Relay	AC-PRO with quick trip

	MFR	Model
Fuse – ANSI (AC)	Bussmann	55GDMSJD, 55GFMSJD, CGL, DCM, FNQ-R, FRS-R (10/02)
	Cooper	Bay-O-Net (353C), ECNR (2009), ECSR (2009)
	Cutler-Hammer	15HLE, Current Limiter – TRI-PAC CB
	Federal Pioneer	JCL, LCL
	Gould Shawmut (Ferraz)	A150X
	Hinode Electric	1000GH
	Littelfuse	JLS, KLNR, KLSR
	Mersen	A155B
	Siba	SQB3

	MFR	Model
Fuse – ANSI (DC)	Bussmann	CGL, DCM, TPB, TPL
	Cooper	ECNR (2009)

This document and the information within it are confidential and proprietary to ETAP/Operation Technology, Inc. and may not be modified, copied, published, disclosed, distributed, displayed or exhibited in either electronic or printed formats without the written authorization of ETAP/Operation Technology, Inc., 17 Goodyear, Suite 100, Irvine, CA 92618, USA. © 2015 ETAP/Operation Technology, Inc. All Rights Reserved.

	Gould Shawmut (Ferraz)	A150X
	Hinode Electric	1000GH
	Littelfuse	KLNR, KLSR
	Mersen	HP6J

	MFR	Model
Fuse – IEC (AC)	Bussmann	170M (Size 24), CJB
	GEC	CJ
	Siba	SQB3, SQB3-2, SQB3-70

	MFR	Model
Fuse – IEC (DC)	Bussmann	CJB
	GEC	CJ

	MFR	Model
Relay	ABB	CA-6, E200DU, GR-200, GRC, HCB1, IKC911, IKC912, IKC913, IRV, LCB II, NI 40/41, PR-512, REB 611, RED 615, REF 550, REF 611, REF 615, REJ 603, REM 611, REM 615, RET 615, REU 615, RI (50 Hz), RI (60 Hz), SPAC 320 C, UMC100-FBP, UMC22-FBP
	AEG	PS431
	Allen Bradley	CGCM, SMC Dialog Plus Controller
	ALSTOM	KBCH 120, KBCH 130, KBCH 140, MBCH 12, MBCH 13, MBCH 16, MBCI, MFAC 14, MFAC 34, MOPN 01, MOPN 02, MX3IPG1A
	AREVA	MCAG 12, MCAG 13, MCAG 19, MCAG 32, MCAG 33, MCAG 39, MCTI 19, MCTI 39, MCTI 40
	Basler Electric	BE1-CDS240, BE1-IPS100, DGC-2020
	Beckwith Electric	M4272
	Cooper	IM30AB
	Eaton	D64RPB100, D64RPB250
	Electromagnetic Industries LLP	GFP
	ERL Phase Power Tech.	8700
	Federal Pioneer	GLR-12S
	Fuji Electric	UM42C, UM42F, UM43FD, UM43FG
	GE Multilin	IBCV51M, IBCV51M(-)Y1A, IBCV52M, IBCV53M, IBCV53M(-)Y1A, IBCV54M, IBCV77M, IBCV78M, PVD21, SMOR-B, STD15C, STD15D, STD16C, STD17C, STD18C, STD21C, STD25D, STD26C, STD28C, STD29C

This document and the information within it are confidential and proprietary to ETAP/Operation Technology, Inc. and may not be modified, copied, published, disclosed, distributed, displayed or exhibited in either electronic or printed formats without the written authorization of ETAP/Operation Technology, Inc., 17 Goodyear, Suite 100, Irvine, CA 92618, USA. © 2015 ETAP/Operation Technology, Inc. All Rights Reserved.

	GEC	CTG 11, CTG 13, CTG 14, CTG 21, CTG 23, CTG 24, CTIG39, FAC14, FAC34
	I-Gard	FALCON ARC PROTECTION
	L&T	MCOMP
	Microelettrica-Scientifica	DMTR, IM30AB, MM30-743, N-DIN-F, N-DIN-MA
	MIKRO	MK1000A, MK201A, MK203A, MK2200, MK300/MK300E
	Motortronics	RX
	Neopis Co.Ltd	PROMET-F
	Omron	SE
	P&B Engineering	M5A, Mn3, Mn4, Mn5A, MR-EF, Mw5A
	Schneider Electric	TeSys LT6-P, TeSys LT6-P (CT)
	Schweitzer	487V, 751A (R410), 849 (R101)
	SELCO	S600
	Siemens	3RB12, 7SG18, 7SS601, 7UT612, 7UT613, 7UT633/635
	Skymatic Controls Inc.	GFR-3
	Square-D	DR-LXS01
	Westinghouse	CA-6

	MFR	Model
MCP	ABB	S2X 80, S3 160, S3 250, Tmax T2 & T3
	Allen-Bradley	140M-J8P
	Cutler-Hammer	HMCPE
	Merlin Gerin	CF-250
	Siemens	HEM

	MFR	Model
Cable	AlcatelWire	Energex-SP
	AmerCable	CIRVFD
	NEC	NEC Tab9 AL, NEC Tab9 PVC, NEC Tab9 ST
	Prysmian	Airguard CSA
	Southwire	SIMPull XHHW/CT
	TFKable	Type DLO

This document and the information within it are confidential and proprietary to ETAP/Operation Technology, Inc. and may not be modified, copied, published, disclosed, distributed, displayed or exhibited in either electronic or printed formats without the written authorization of ETAP/Operation Technology, Inc., 17 Goodyear, Suite 100, Irvine, CA 92618, USA. © 2015 ETAP/Operation Technology, Inc. All Rights Reserved.



System Requirements

Operating System (64-bit)

Microsoft Windows® 10 Pro
Microsoft® Windows® 8 & 8.1 (Standard, Professional)
Microsoft® Windows 7 (Home Premium, Professional, Ultimate) (SP 1)
Microsoft® Server 2012 & 2012 R2 (Standard)
Microsoft® Server 2008 R2 (Standard) (SP1)

Other Software Requirements

Internet Explorer® 10 or higher (or minimum version level specified by the Operating System)
Microsoft .NET Framework v3.5 (SP1)
Microsoft .NET Framework v4.0
Microsoft .NET Framework v4.5
Microsoft SQL Server Compact 3.5 (SP2)
Microsoft Windows Update (KB2670838)
Microsoft SQL Server 2012 Express (x64)
Microsoft SQL Server 2012 Express LocalDB (x64)
Microsoft SQL Server 2012 Native Client (x64)
Microsoft SQL Management Studio 2012 (x64)

PC Configuration Requirements

64-bit hardware
USB port
Ethernet port w/ network access (if network licensing required)
DVD Drive, 10 to 80 GB hard disk space (based on project size, number of buses)
19" monitors recommended (dual monitors highly recommended)
Recommended display resolution -1280 X 1024

Recommended Hardware

100 Bus Projects

Intel Core i5 or better – 2.0 GHz or better (or equivalent)
4 GB RAM

500 Bus Projects

Intel Core i5 or better – 2.0 GHz or better (or equivalent)
8 GB RAM

1,000 Bus Projects

Intel Core i5 or better – 3.0 GHz with Hyper-Threading & high speed bus (or equivalent)
16 GB RAM (high-speed)

10,000 Bus Projects and Higher

Intel Core i5 or better – 3.0 GHz with Hyper-Threading & high speed bus (or equivalent)
32 GB RAM - (high-speed)

This document and the information within it are confidential and proprietary to ETAP/Operation Technology, Inc. and may not be modified, copied, published, disclosed, distributed, displayed or exhibited in either electronic or printed formats without the written authorization of ETAP/Operation Technology, Inc., 17 Goodyear, Suite 100, Irvine, CA 92618, USA. © 2015 ETAP/Operation Technology, Inc. All Rights Reserved.



ETAP 12.6.5

February 2015

The ETAP Development Team is pleased to provide you with the ETAP 12.6.5 release.

ETAP 12.6.5 is a point release to 12.6. This is a complete installation which does not require an earlier installation of ETAP.

Included in this latest release are enhancements to the Checker access-level action for Revision data, cable temperature calculations for 1/C cables with random arrangements in underground duct banks, and library data.

ETAP 12.6.5 System Requirements

Operating System (32-bit or 64-bit)

Microsoft® Server 2012 (Standard)
Microsoft Windows® 8 & 8.1 (Standard, Professional)
Microsoft Windows 7 (Home Premium, Professional, Ultimate) (SP 1)
Microsoft Windows Vista (Home Premium, Business, Enterprise) (SP 2)
Microsoft Windows XP (Home Edition, Professional) (SP 3)
Microsoft Server 2008 R2 (Standard)
Microsoft Server 2008 (Standard)
Microsoft Server 2003 R2 (Standard) (SP 2)
Microsoft Server 2003 (Standard) (SP 2)

Other Software Requirements

Internet Explorer® 5.01 or higher (or minimum version level specified by the Operating System)
Microsoft .NET Framework v3.5 (SP 1)
Microsoft SQL Server Compact 3.5 (SP2)

PC Configuration Requirements

USB port (if stand-alone licensing required)
Ethernet port w/ network access (if network licensing required)
DVD Drive 10 to 80 GB hard disk space (based on project size, number of buses)
19" monitors recommended (dual monitors highly recommended)
Recommended display resolution -1280 X 1024

Recommended Hardware Requirements

100 Bus Projects

Intel Dual/Quad core – 2.0 GHz or better (or equivalent)
2 GB of RAM



500 Bus Projects

Intel Dual/Quad core – 2.0 GHz or better (or equivalent)
4 GB of RAM

1,000 Bus Projects

Intel Dual/Quad core – 3.0 GHz with Hyper-Threading & high speed bus (or equivalent)
8 GB of RAM (high-speed)
64-bit Operating System

10,000 Bus Projects and Higher

Intel Dual/Quad core – 3.0 GHz with Hyper-Threading & high speed bus (or equivalent)
12 GB RAM - (high-speed)
64-bit Operating System



ETAP 12.6

March 2014

ETAP is pleased to provide you with the enclosed ETAP 12.6 point release. ETAP 12.6 is a complete program and does not require any previous ETAP installation.

This point release is the latest in the ETAP 12 series and includes important updates based on the industry's latest demands. This Readme contains key information about ETAP that may not be included in Help file.

ETAP continues to expand and enhance its capabilities based on the requirements of the industry. In ETAP 12.6, the Unbalanced Load Flow module was enhanced to simulate double open-phase faults. This enhancement is in response to the requirements for the nuclear generation plants to conduct single and double open-phase fault studies for their off-site power supplies. Enhancements to the Unbalanced Load Flow module include:

- Simulate a double open-phase fault at any terminal of a three-phase branch
- Transition of motors to locked rotor conditions based on undervoltage conditions
- Display of current angle on the one-line diagram

IEEE exciter type AC7B has been modified based on IEEE 421.5 errata from June of 2008. Previous versions of ETAP included detailed modeling of the AC7B excitation system based on IEEE standard 421.5-2005. The revised model includes exciter time constant modeled as an integrator rather than a simple time constant. The enhanced AC7B model also includes the load current compensation circuit as described in section 4, figure 4-1, of 421.5-2005. The load current compensation circuit can be used to effectively regulate voltage at a point beyond the terminal of the generator and compensate for step-up transformer drops. Additional enhancements and capabilities include:

Module Enhancements

- *Load Flow*
- *Unbalanced Load Flow*
- *Transient Stability*
- *Arc Flash*
- *Transformer Ratings*
- *Device Libraries*

Multi-Language Edition

- *English*
- *Spanish*
- *Chinese*
- *Japanese*
- *Russian*
- *Portuguese*
- *Korean*
- *German (output reports only)*

Upon finishing installation of ETAP 12.6, a new 36-digit activation code is required to activate and open the application. The activation code is provided on the ETAP 12.6 installation DVD.



System Requirements

Before you install ETAP 12.6, make sure that your computer meets the recommended hardware and software requirements listed below.

Operating System (32-bit or 64-bit)

Microsoft® Server 2012 (Standard)
Microsoft Windows® 8 & 8.1 (Standard, Professional)
Microsoft Windows 7 (Home Premium, Professional, Ultimate) (SP 1)
Microsoft Windows Vista (Home Premium, Business, Enterprise) (SP 2)
Microsoft Windows XP (Home Edition, Professional) (SP 3)
Microsoft Server 2008 R2 (Standard)
Microsoft Server 2008 (Standard)
Microsoft Server 2003 R2 (Standard) (SP 2)
Microsoft Server 2003 (Standard) (SP 2)

Other Software Requirements

Internet Explorer® 5.01 or higher (or minimum version level specified by the Operating System)
Microsoft .NET Framework v3.5 (SP 1)
Microsoft SQL Server Compact 3.5 (SP2)

PC Configuration Requirements

USB port (if stand-alone licensing required)
Ethernet port w/ network access (if network licensing required)
DVD Drive 10 to 80 GB hard disk space (based on project size, number of buses)
19" monitors recommended (dual monitors highly recommended)
Recommended display resolution -1280 X 1024

Recommended Hardware Requirements

100 Bus Projects

Intel Dual/Quad core – 2.0 GHz or better (or equivalent)
2 GB of RAM

500 Bus Projects

Intel Dual/Quad core – 2.0 GHz or better (or equivalent)
4 GB of RAM

1,000 Bus Projects

Intel Dual/Quad core – 3.0 GHz with Hyper-Threading & high speed bus (or equivalent)
8 GB of RAM (high-speed)
64-bit Operating System

10,000 Bus Projects and Higher

Intel Dual/Quad core – 3.0 GHz with Hyper-Threading & high speed bus (or equivalent)
12 GB RAM - (high-speed)
64-bit Operating System



ETAP 12.5

August 2013

The ETAP Development Team is pleased to provide you with the enclosed ETAP 12.5 release. ETAP 12.5 is a complete program and does not require any previous ETAP installation.

ETAP 12.5 release is the latest upgrade of the market-leading electrical power system design and operation software. The new analysis features and enhanced capabilities effectively enable optimized design, increasing safety, quality, and productivity.

ETAP 12.5 Faster Than Real-Time™ solution provides for better decision making, improved operations management, cost saving, and compliancy.

Upon finishing installation of ETAP 12.5, a new 36-digit activation code is required to activate and open the application. The activation code is provided on the ETAP 12.5 installation DVD.

For more information on this new release, please take a few moments to review the information below.

New Features & Capabilities

- *Dynamic Parameter Estimation & Tuning - DPET*
- *Short Circuit GOST R 52735 Standard*
- *New Web Consoles for Monitoring & Simulation*
- *Customizable Web Console Templates*
- *Native e-SCADA Communication Protocols*
- *Waveform Capturing & Synchrophasor Measurements*
- *New Library Merge & Cable Library Quick-Pick*
- *Enhanced Analysis Modules*
- *3,500 New Device Libraries*
- *Multi-Language Edition*



New Features

Dynamic Parameter Estimation & Tuning - DPET

Combined with the UDM variable parameter capability, DPET adds a whole new layer in time saving capabilities which can literally save hundreds of engineering man-hours spent on the tedious process of model validation parameter tuning.

Features

- Tune dynamic models with multiple input/output
- Estimate model parameters using actual field measurements
- Utilize field data from disturbance recorders & PMUs
- Automatically exclude questionable data & filter noise
- Compliance with NERC MOD standards
- Multi-objective stochastic optimization method
- Utilize ETAP User-Defined Dynamic Model to build custom models
- Combinations of models: Generators, Governors, Exciters, Power System Stabilizers, Dynamic Loads, Networks, etc.
- Graphical platform to create and edit dynamic models
- Generate comparisons of multiple estimation results
- Determine model parameters resulting in the best model & measured data fit
- View parameter sensitivity, measured vs. simulated model outputs, & residual values
- View & compare tuned parameters for New Case
- Multiple sets of input/output data-files for tuning comparison
- Easily change the parameter initial values, including block limits

GOST Standard R 52735 Compliance

Save hours of tedious hand calculations, manual excel manipulations, and take the guesswork out of short-circuit studies by automating the process with multiple calculations and result analysis.

Features

- Calculate periodic & aperiodic components and surge current
- Consider pre-fault loading condition
- Calculation of short-circuit current at any specified time
- Radial and multi-loop circuit calculations
- GOST short-circuit output report in Russian language



Scenario Wizard Enhancements

ETAP Scenario Wizard now includes the ability to automatically run multiple Underground Raceway System scenarios with different project files and verify their study results against benchmark reports. Once the scenarios are set up, you can compare hundreds of study reports together with one click.

Features

- New Underground Raceway System (UGS) Scenarios
- Direct access to Study Cases Editors
- Direct access to Revision and Configuration Managers
- Automatically compare, verify and validate Transient Stability plots
- Export plots and data points to Excel
- Simulate “What if” events
- Dynamic update of preference file; INI entries

New Cable Library Quick Pick Editor

Cable library quick pick editor is enhanced to provide an easy to use search environment to quickly locate the cable in your facility from within the library. Utilize powerful search and sort tools to quickly filter specific groups of cables.

Library Merge Utility

Faster library file merge process.

Features

- New library merge process with increased speed
- Create custom library files faster
- Enhanced library merge functionality



ETAP Real-Time

Distributed Electrical SCADA Technology

ETAP e-SCADA technology allows you to, predict, control, visualize, optimize, summarize and automate your power system. Distributed and web-based technologies provide the tools to make informative decisions based on planned or unplanned events from any location.

Features

- Smart Grid & Microgrid Master Controllers
- Real-Time decision making applications
- Predictive Simulation, Optimization & Automation
- Online & archive data trending
- Operator training simulator
- Enhanced e-SCADA component library
- Web-based SCADA architecture

Thin Client & Web Consoles

As the demand for web-based design and simulation increases, ETAP has created a powerful web-based interface to build and model your electrical system through an accessible URL.

Features

- Thin client applications
- Automatically generate electrical diagrams from ETAP
- Intelligent web graphical user interface
- HMI template library
- Configurable web visualization & control
- Electrical grid view - Geographical map
- Utilize geospatial maps for situational awareness
- Alarm & warning views
- Flexibility to create “what if” scenarios

Direct Communication Protocols

ETAP offers direct connectivity to any industry compliant systems. While maintaining open connectivity with the industry’s standard hardware components, this additional functionality provides enhanced flexibility, higher performance, and easy to configure architectures.

New and Enhanced Features

- IEC 61850
- Modbus
- DNP3
- OPC
- OPC UA



Disturbance Monitoring & Wave Capturing

ETAP provides the ability to replay recorded voltage and current waveforms; visualize and analyze power quality throughout the system.

Features

- Digital Fault Recorder
- Synchrophasor Measurement Unit (PMU)
- Replay recorded voltage & current waveforms
- Capture data from Disturbance Monitoring Equipment:
 - COMTRADE Sequence of Events Recorders & PMUs
 - Fault & Dynamic Disturbance Recorders
- Online & archive data trending:
 - Current
 - Voltage
 - Power
 - Frequency

Multi-Language Editions

ETAP interface is localized in 7 languages and provides output reports in 8 languages.

Languages

- English
- Spanish
- Chinese
- Japanese
- Russian
- Portuguese
- Korean
- German (output reports only)

Library Additions

The following protective device manufacturers and models are added to the library.

	MFR	Model
LVCB - ANSI	ABB	E1B-A(2005),E1N-A(2005),E2B-A(2005),E2H-A(2005),E2N-A(2005),E2S-A(2005),E3H-A(2005),E3N-A(2005),E3S-A(2005),E3V-A(2005),E3X-A(2010),E4H-A(2005),E4H-A/f(2005),E4L-A(2005),E4L-A(2010),E4S-A(2005),E4V-A(2005),E6H-A(2005),E6H-A/f(2005),E6L-A(2005),E6V-A(2005),E6X-A(2010),E6X-A/f(2010),X1N-A(2008)
	Allen-Bradley	140U-I0C3,140U-I3C3,140U-I6C3,140M-I8P,140M-I8R,140U-J0C3,140U-J2C3,140U-J3C3,140U-J6C3,140U-JD0,140U-JD3,140U-JD6,140U-K0X3,140U-K3X3,140U-K6X3,140U-L0,140U-L3,140U-L6,140U-I0C3, 140U-I3C3, 140U-I6C3,140U-JD0,140U-JD3,140U-JD6,140U-K0X3,140U-K3X3,140U-K6X3
	Cutler Hammer	AQB-A103
	General Electric	FEH,FEL,FEN,TEYD,TEYH,TEYL
	Schneider Electric	NSX100-F,NSX100-H,NSX100-N,NSX160-F,NSX160H,NSX160-N,NSX250-F,NSX250-H,NSX250-N,NSX400F,NSX400-H,NSX400-N,NSX630-F,NSX630-H,NSX630-N
	Square-D	HD,HG,HJ,HL,JD,JG,JJ,JL,LD,LG,LJ,LL
	Terasaki	AH-40C, AH-60C
	K Moeller	NZMH2,NZMH3,NZMN3
LVCB - IEC	ABB	E1B(2005), E1N(2005), E2B(2005), E2L(2005), E2N(2005), E2S(2005), E3H(2005), E3L(2005), E3N(2005), E3S(2005), E3V(2005), E4H(2005), E4H/f(2011), E4S(2005), E4S/f(2011), E4V(2005), E6H(2005), E6H/f(2011), E6V(2005), X1B(2008), X1L(2008), X1N(2008)
	Allen-Bradley	140U-J0C3, 140U-J2C3, 140U-J3C3, 140U-J6C3, 140U-JD0, 140U-JD3,140U-JD6, 140U-K0X3, 140U-K3X3, 140U-K6X3, 140U-L0 (250A-400A),140U-L0 (500A), 140U-L0 (600A), 140U-L3 (250A-400A),140U-L3 (500A), 140U-L3 (600A), 140U-L6 (250A-400A),140U-L6 (500A), 140U-L6 (600A), 140U-JD0, 140U-JD3, 140U-JD6
	K Moeller	NZMH2, NZMH3 (250A-400A), NZMH3 (450A), NZMH3 (500A), NZMH3 (550A), NZMH3 (600A),NZMN3 (250A-400A), NZMN3 (450A), NZMN3 (500A), NZMN3 (550A), NZMN3 (600A)
	LSIS	AH-06D,AH-08D,AH-10D,AH-13D,AH-16D,AH-20D,AN-06D,AN-08D,AN-10D,AN-13D,AN-16D,AS-20D,AS-20E,AS-25E,AS-32E,AS-40E,AS-40G,AS-50F,AS-50G,AS-63G
	Schneider Electric	NSX100-B,NSX100-F,NSX100-H,NSX100-L,NSX100-N,NSX100-S,NSX160-B,NSX160-F, NSX160-H, NSX160L,NSX160-N,NSX160-S,NSX250-B, NSX250-F,NSX250-H,NSX250-L,NSX250-N, NSX250-S,NSX400-H,NSX400-L,

		NSX400-N, NSX400-S, NSX630-H, NSX630-L, NSX630-N, NSX630-S
	Square-D	HD, HG, HJ, HL, JD, JG, JJ, JL, LD, LD(600A), LG, LG(600A), LJ, LJ(600A), LL, LL(600A)
	Terasaki	AH-40C, AH-60C
	Toshiba	NJ100MB, NJ100NB, NJ100NB-T, NJ100P, NJ50EB, NJ50FB NJ100MB, NJ100NB, NJ100NB-T, NJ100P, NJ50EB, NJ50FB
TM	ABB	A1 125A - TMF Cold, A1 125A - TMF Hot, T1, T2, T3, T4, T4 (IEC), T5, T5 (IEC)
	Allen-Bradley	140U-I0C3, 140U-I3C3, 140U-I6C3, 140U-J, 140U-JD0, 140U-JD3, 140U-JD3 (DC), 140U-K0, 140U-K0 (DC), 140U-K3, 140U-K3 (DC), 140U-K6, 140U-K6 (DC), 140U-L
	GE Power Controls	TEYD, TEYH, TEYL
	K Moeller	NZM2-A(F), NZM3-AE, NZM3-AEF
	Schneider Electric	TM100D, TM125D, TM16, TM160D, TM200D, TM25, TM250D, TM32D, TM40, TM50D, TM63, TM80D
	Square-D	Powerpact H-frame (50Hz), Powerpact H-frame (60Hz) Powerpact J-frame (50Hz), Powerpact J-frame (60Hz)
	Toshiba	NJ100P, NJ50EB
LVSST	ABB	PR331/P (IEC-2008-X1), PR331/P (UL-2008-X1), PR332/P (IEC-2008-X1), PR332/P (UL-2008-X1), PR333/P (IEC-2008-X1), PR333/P (UL-2008-X1), SACE PR111, SACE PR112, SACE PR112 (IEC), SACE PR121, SACE PR121/P (IEC), SACE PR122, SACE PR122/P (IEC), SACE PR123 (UL) SACE PR123/P (IEC), SACE PR211, SACE PR212, SACE PR221 (T2), SACE PR221 (T4), SACE PR221 (T5), SACE PR222
	Allen-Bradley	140U-J (LS), 140U-J (LSG), 140U-J (LSI), 140U-J (LSIG)
	Cutler Hammer	Navy AQB-A103 (1/10)
	General Electric	SMR1 (FE, 240V), SMR1 (FE, 480V)
	LSIS	A Type, N Type, P Type, S Type
	Schneider Electric	Micrologic 1.3 M (NSX), Micrologic 2.2 (NSX) Micrologic 2.2 G (NSX), Micrologic 2.2 M (NSX) Micrologic 2.3 (NSX), Micrologic 2.3 M (NSX) Micrologic 5.2 A/E (NSX), Micrologic 5.3 A/E (NSX) Micrologic 6.2 A/E (NSX), Micrologic 6.2 E/M (NSX) Micrologic 6.3 A/E (NSX), Micrologic 6.3 E/M (NSX)
	Square-D	Micrologic 1.3 M (PP), Micrologic 2.2 M (PP) Micrologic 2.3 M (PP), Micrologic 3.2 (PP) Micrologic 3.2S(PP), Micrologic 3.3 (PP) Micrologic 3.3S(PP), Micrologic 5.2 A/E (PP) Micrologic 5.3 A/E (PP), Micrologic 6.2 A/E (PP) Micrologic 6.3 A/E (PP)

	MFR	Model
Fuse - ANSI	Bussman	FRN-R (10/08), TJN
	Cooper	ELSP (08/12), ELSP (08/12),ELSP (08/12)
	Cutler-Hammer	CLE2 (7/03),CLE3 (7/03)
	Mersen	CP

	MFR	Model
Relay	ABB	ICM2
	ALSTOM	MX3IPD1A, MX3IPD1B
	BBC	ICM2(50Hz), ICM2(60Hz), ICM21(50Hz)
	Basler Electric	BE1-87B, BE1-87G, BE1-87T
	LSIS	IMP
	Schneider Electric	TeSys T
	Siemens	ESP200

	MFR	Model
Recloser	Cooper	RX <100A Coil>,RX <140-225A Coil>,RX <25A Coil>, RX <280A Coil>,RX <280X Coil>,RX <35A Coil>,RX <400A Coil>, RX <400X Coil>,RX <50A Coil>,RX <70A Coil>

	MFR	Model
TMCP	ABB	T2 160-MA,T2 160-MF,T3 250-MA,T4 250-MA
	Allen-Bradley	140M-I

	MFR	Model
Cable	BICC	3X1/C Parallel Empower Fill Concentric Neutral Power Cable



System Requirements

Operating System (32-bit or 64-bit)

Microsoft® Server 2012 (Standard)
Microsoft Windows® 8 (Standard, Professional)
Microsoft Windows 7 (Home Premium, Professional, Ultimate) (SP 1)
Microsoft Windows Vista (Home Premium, Business, Enterprise) (SP 2)
Microsoft Windows XP (Home Edition, Professional) (SP 3)
Microsoft Server 2008 R2 (Standard)
Microsoft Server 2008 (Standard)
Microsoft Server 2003 R2 (Standard) (SP 2)
Microsoft Server 2003 (Standard) (SP 2)

Other Software Requirements

Internet Explorer® 5.01 or higher (or minimum version level specified by the Operating System)
Microsoft .NET Framework v3.5 (SP 1)
Microsoft SQL Server Compact 3.5 (SP2)

PC Configuration Requirements

USB port (if stand-alone licensing required)
Ethernet port w/ network access (if network licensing required)
DVD Drive 10 to 80 GB hard disk space (based on project size, number of buses)
19" monitors recommended (dual monitors highly recommended)
Recommended display resolution -1280 X 1024

Recommended Hardware Requirements

100 Bus Projects

Intel Dual/Quad core – 2.0 GHz or better (or equivalent)
2 GB of RAM

500 Bus Projects

Intel Dual/Quad core – 2.0 GHz or better (or equivalent)
4 GB of RAM

1,000 Bus Projects

Intel Dual/Quad core – 3.0 GHz with Hyper-Threading & high speed bus (or equivalent)
8 GB of RAM (high-speed)
64-bit Operating System

10,000 Bus Projects and Higher

Intel Dual/Quad core – 3.0 GHz with Hyper-Threading & high speed bus (or equivalent)
12 GB RAM - (high-speed)
64-bit Operating System



ETAP 12.0.0

January 2013

The ETAP Development Team is pleased to provide you with the enclosed ETAP 12.0.0 release. ETAP 12.0.0 is a complete program and does not require any previous ETAP installation.

ETAP 12.0.0 is a major release that advances our continued shared commitment with clients and business partners to provide the most comprehensive analytical solutions for the design and operation of power systems now, and the energy technologies for tomorrow. As the industry's market leader, ETAP delivers the future of power systems engineering and operation – today. The new enhancements and analysis modules are still developed with mathematical precision using our Quality Assurance and Verification & Validation Procedures.

Upon finishing installation of ETAP 12.0.0., a new 36-digit activation code is required to activate and open the application. The activation code is provided on the ETAP 12.0.0 installation CD.

For more information on this new release, please take a few moments to review the information below.

New Features

- *Auto-Connect*
- *Adaptive Newton-Raphson Method*
- *Switching Device Interlock Enforcer*
- *Cable Manager*
- *Cable Constants*
- *Import from SKM® Captor™*
- *Import from EasyPower®*
- *License Borrowing*
- *Polyline Text Box*

New Analysis Modules

- *Interharmonics*
- *Open-Phase Fault*
- *Arc Flash Sequence-of-Operation*

Enhanced Modules

- *Load Flow*
- *Unbalanced Load Flow*
- *AC Arc Flash Analysis*
- *Harmonics*
- *Motor Starting & Acceleration*
- *Transient Stability*
- *Switching Sequence Management*
- *Underground Thermal Analysis*
- *Project Merge*
- *Data Exchange*

Enhanced Elements

- *Photovoltaic (PV) Panels*
- *Buried Delta Transformer*
- *Cables*
- *Inverter*
- *Power Grid*
- *DC Circuit Breaker*
- *Charger*
- *Uninterruptible Power Supply*
- *Variable Frequency Drive*
- *Inverter*



1. New Features

Auto-Connect

A new tool is added to increase the efficiency and convenience of connect or disconnect the elements on one-line.

Features

- Automatic equipment connection mode
- Automated selection of available pins
- Auto connection to closest highlighted element
- Auto Disconnect & Reconnect

Adaptive Newton-Raphson

This new Newton-Raphson method has been added to most modules requiring load flow calculations, such as Load Flow, Motor Starting, Harmonic Analysis, Transient Stability Analysis, and Optimal Capacitor Placement, etc. The method greatly enhances convergence of load flow calculations for special system configurations and operating conditions that do not yield a solution by regular Newton-Raphson method. When it determines such a case, it adaptively adjusts the step size of the iterative calculation process to provide a solution.

Features

- Increased convergence for systems with negligible impedance
- Improved handling of transmission line series capacitors (i.e. negative line series reactance)

Switching Device Interlock Enforcer

Switching interlock enforcer is an easy to use module in ETAP that allows the engineer to design and simulate the system while being aware of the existing interlocking between switching devices in the system. This has the potential to prevent the engineer from designing system configurations that are not allowed and save time by simulating scenarios that are unnecessary due existing interlocks. As well as checking for interlocks that prevent the user from changing the configuration of switching devices, it also checks if switching a device will trigger the switching of another device or a chain of other devices. The interlocking can be based on the configuration of another switching device or based on a meter readings updated by running Load Flow study.

Features

- Auto enforcement of switching interlock logics
- Automatic pre-switching & post-switching logic verification
- Interlock based on switching devices positions
- Interlocks based on load flow results, power flows and voltages
- Automatic interlock conflict checking
- Ability to model cascade control of switching devices
- Active monitoring of switching interlock violations
- Switching plan validation against hazardous actions

Cable Manager

The Cable Manager allows the “batch” management of all the cable data, as they appear in the Cable Editors of each cable. The Cable Manager shows cable data in a consolidated fashion in a grid; with the



presence of intelligent filters, cables can be searched and grouped by their relevant parameters, thereby simplifying their engineering management. Cable Manager allows batch reporting and selecting from library.

Features

- Batch cable management
- Customizable cable reports
- Multi-cable sizing & shock protection evaluation
- Intelligent search and filtering
- Export to Excel sheets

Import from SKM[®] Captor[™]

Enhanced SKM import utility that allows for the automatic conversion of projects created in SKM including automatic protective device mapping and TCC import. This data exchange tool allows for direct import of SKM Dapper[®] PTW32 versions 6.0 & 6.5.

Features

- Converts Dapper[®] PTW32 versions 6.0 & 6.5
- Import CAPTOR TCCs into STAR
- Automatic, one click conversion of SKM Dapper projects
- One-line diagram layout conversion per the original project drawing
- Support for multiple one-Line drawing into composite networks
- Automatic protective device settings mapping
- Conversion of AC & DC networks

Import from EasyPower[®]

ETAP 12.0 brings a brand new EasyPower import utility that allows for the automatic conversion of projects created in EasyPower ver. 8.0 and 9.0.

Features

- Automatic import of AC elements including all their input data
- Library mapping utility for importing protective device settings for fuses, Low voltage circuit breakers and trip units as well as relays
- Automatic One-Line diagram import to match the original project layout
- Import of EasyPower TCCs into Etap's STAR coordination module

Polyline Text Box (highlight polyline shape)

Create a polygonal chain to highlight different sections of the one-line diagram.

Features

- Freehand polyline shapes & styles
- Graphically define revision boundary on the OLV
- Dynamic textbox object
- Save with OLV Templates



License Checkout/Borrowing

The ETAP license manager has been enhanced to include License Checkout/Borrowing, also known as “Check-Out” license. ETAP 12 License Manager provides the ability to allow the user to borrow or check out a license from the host network for a specified amount of time. The engineer can select the amount of days to borrow the license, up to a maximum of 120 days, and then use that license away from the network before that seat is automatically returned. During the time the license is borrowed, the checked out license is removed from the available licenses in the network and can be used on the computer as a keyless seat outside the network.

Capabilities:

- License borrowing option can be set up through the ETAP LM Configuration utility.
- Borrowed license can run with the computer disconnected from the network until the borrowing period ends.
- Borrowed duration is determined per user account.
- LM tracks and keeps count of remaining / available licenses for checkout
- Borrowed license duration can be configured from 1 day up to 120 days
- Borrowed licenses are linked to the computers used during checkout

License Manager

The license manager also includes an editor for IT administrators to enhance the management of license usage. The new license manager editor allows the administrator to monitor the number of users and the time they logged in. From this manager, the IT administrator can remove a connected user from the user list and make a license available for others.

Features

- License Checkout/Borrowing
- Start/Stop Service
- View Logon Time
- Remove connected users



2. New and Enhanced Modules

Interharmonics

ETAP Harmonic Analysis module has been enhanced with new features including interharmonic modeling and studies, options to use device/equipment rating or fundamental frequency load flow data as harmonic current source or voltage source base, along with a new design of Harmonic Library to allow user inputting harmonic spectrum up to 250th harmonic order, or automatically populating harmonic order, magnitude and phase angle based on power converter pulse number and other parameters.

Features

- Interharmonic modeling & simulation
- Perform voltage flicker limitation studies
- Interharmonic distortion indices calculation based on IEC 61000-4-7
- Handling of harmonic order up to 250th order
- Automatic interharmonic frequency generation
- Manual or automatic harmonic spectrum generation
- Adjustable harmonic current base

Open Phase Simulation by Unbalanced Load Flow Analysis

The Unbalanced Load Flow Analysis module has been enhanced to accurately simulate steady-state open-phase conditions of power systems. An open-phase condition (on phase A, B, or C) can be studied by placing a graphical icon on the one-line diagram at the terminal of branch. In order to study this extremely unbalanced operating conditions, induction motor models have been enhanced in the unbalanced load flow calculations.

Features

- Open-Phase A, B, or C phase
- Modeling of 2-winding and 3-winding transformer excitation branch
- Include buried delta winding for 2-winding and 3-winding transformers
- Report sequence values of voltages and current flows

AC & DC Arc Flash Analysis

The arc flash analysis module was significantly enhanced with many features requested to handle specific problems and conditions encountered for many types of power systems. The enhanced systems include those with a lot renewable energy sources and extremely complex multiple energy source configurations. The highlight enhancement or new feature for this module is the AFSQOP tool. The arc flash sequence of operation (AFSQOP) tool enhances the graphical analysis of the power system protection behavior under “arc fault” conditions. The fault insertion, arc flash result analyzer and sequence viewer tools help to determine what is the effect of the arc fault conditions like current variation and decay, missing energized sources and miscoordination issues. AFSQOP however has taken the individual fault analysis to the next level by storing and playing back the sequence of events for every faulted location. Combined with the ETAP STAR sequence of operation tool, ETAP now has two simulators to show the behavior of protected devices under both bolted and arcing fault conditions.

New and Enhanced Features

- Graphical Simulation of 3 & 1-Phase Arc Flash Sequence-of-Operation
- Tabulated display of protective device trip sequence using the “Arc Flash SQOP Viewer



- Single Arc Fault Insertion Tool
- Playback of multiple arc flash sequence of operation using the arc flash result analyzer
- Sequence of operation playback speed controls (to speed up slow down or remove the sequence flashing on the one-line diagram)
- Two user-defined modes of operation for the AFSQOP to display first de-energizing PD only or to view multiple source PD operations
- Exporting to MS Excel of all protective device sequence of operation
- Automatic verification of protective device short-circuit duty using bolted fault currents prior to arc flash calculation.
- Enhanced source protective device search capability for systems with multiple energizing sources (including renewable energy)
- Saving of all settings and display preferences in the Arc Flash result analyzer, including more significant figures and additional filtering tools.
- Non-modal AFRA to aid in the analysis and to take advantage of multiple monitors
- User-definable Cf for low voltage equipment incident energy (IEEE 1584-2002 empirical method)
- Enhanced display of results on the one-line diagram including the fault clearing time
- Use the “Maximum Fault Clearing Time” time setting to determine incident energy when the fault clearing time is unavailable
- DC Photovoltaic System Arc Flash calculation which includes iterative method solution based on the operating point on the PV curves.
- Added additional information fields to start collecting information about conductor configurations (i.e. vertical in a box, horizontal in a box, vertical open air, etc). These fields are for information only in preparation for upcoming new changes to IEEE 1584 guidelines.
- Enhanced handling of tie-protective device configurations. Allow different equipment type configurations across a tie-pd bus. The worst-case incident energy is reported for the tie-pd.
- Enhanced handling of automatic incident energy assignment for low voltage equipment. This enhancement allows for assignment of actual incident energy value rather than a hazard/risk category. Also, it allows for the use of this tool with the NFPA 70E 2012 PPE requirements (for arc flash analysis method based on annex H of the standard).

Switching Sequence Management

Switching Management is an easy to use module in ETAP that allows the engineer/dispatcher to build and simulate a complete switching sequence using a graphical user interface and execute the switching plan. The switching sequence contains a list of switching devices and time of execution for circuit breakers, load disconnects, and ground disconnects. Before any switching sequence is executed, the application verifies whether the sequence is compliant with safety switching procedures and requests confirmation during execution of each step before proceeding to the next step in order to avoid inadvertent switching. Switching plan may be configured for automatic transfer of bus loads on double-ended bus configurations thus replacing the step-by-step method of switching for double-ended bus configurations that require manual bus load transfer. Switching sequences can be ranked based on de-energized time, non-delivered energy, and the order of switching allowing easy comparison between different variations of the plan.

Features

- User-friendly switching plan builder



- Point & click selection of switching device from the one-line diagrams
- Graphical display of selected switching devices
- Multi-level switching request approval
- Assignment of user-definable & interlock logic per each switching device
- Checking of selected switching plans against forbidden or potentially hazardous actions
- Unlimited switching plans each with an unlimited number of switching actions
- Switching order reports include switching mode, start / stop time, & nature of work
- Simulate & evaluate switching plans in all states prior to execution

Low Voltage Systems

ETAP has been enhanced for grounding and earthing sources, cable thermal sizing and electric shock calculation in low voltage systems.

New and Enhanced Features

- Enhanced single phase cables with IEC symbols
- Enhanced capabilities in Electric Shock calculation
- Enhanced Electric Shock model input data
- Integration of the Electric Shock Results within TCC plots

Underground Thermal Analysis

ETAP has been enhanced to allow the user to specify Shield Thickness, Sheath Thickness and Armor Diameter individually. Shield has its Grounding selection while Sheath and Armor have common grounding. ETAP also added the capability to have different order of layers in cable configuration. Underground Raceway System (UGS) module handles all these flexibilities automatically in calculation.

Project Merge

Project Merge functionality has been enhanced to allow the user to include TCCs in an export when exporting a portion of the project.



3. New and Enhanced Elements

Photovoltaic (PV) Panels

- Discrete DC Photovoltaic panel element
- Constant current source modeling
- Model PV systems with individual panels
- Detailed modeling considers string cables & combiner boxes
- DC Load Flow and Short-circuit system analysis
- DC Arc Flash Analysis
- Modeling based on P-V & I-V curves

Transformer

- 2W & 3W buried Delta transformer
- Calculation of zero sequence based on test data
- Core & shell type mechanical construction
- 3L, 4L & 5L models

Cables

- Automatic cable positive sequence impedance calculation
- Automatic cable zero sequence impedance calculation
- Global System Frequency Impedance adjustment
- Cable Constants
- Cable Armor thermal calculation
- Cable Sheath thermal calculation
- Calculations based on BS 5467, BS 7671 & IEC 60364
- Enhanced Cable Reports

Inverter

- MPPT controller to interact with DC PV Array Systems
- Enhanced modes of operation for load flow simulations

Power Grid

- Enhanced 3-Phase and 1-Phase grounding impedance models

DC Circuit Breaker

- Added additional trip device and trip unit capabilities (similar to AC LV circuit breakers)

Power Converter Equipment (Charger/UPS/VFD/SVC/Inverter)

- Enhanced the Harmonic Spectrum Calculation Equation by using the IEEE 519 Equation
- Added additional interharmonics interface



Library Additions

The following protective device manufacturers and models are added to the library.

	MFR	Model
LVCB - ANSI	ABB	S8V
	Allen-Bradley	140U-D (0.5-10A), 140U-D (12-30A), 140U-K0X3, 140U-K3X3, 140U-K6X3
	Carling Technologies	F-Series
	Cutler Hammer	CHH, EC, EHC, FC, FDCE, FDE, GDB, GHQ, HGHB, HGHC, HFDE, MDD-X40 (2012), MDD-X50 (2012), MDD-X60 (2012), MDN-408 (2012), MDN-416 (2012), MDN-508 (2012), MDN-516 (2012), MDN-608 (2012), MDN-616 (2012), MDN-620 (2012), MDN-640 (2012), MDN-840 (2012), MDN-C08 (2012), MDN-C16 (2012), MDN-C20 (2012), MDN-C40 (2012), MDS-408 (2012), MDS-608 (2012), MDS – 612, MDS-616 (2012), MDS-620 (2012), MDS-632 (2012), MDS-808 (2012), MDS-816 (2012), MDS-820 (2012), MDS-832 (2012), MDS-840 (2012), MDS-850 (2012), MDS-C08 (2012), MDS-C16 (2012), MDS-C20 (2012), MDS-C32 (2012), MDS-C40 (2012), MDS-C50 (2012), MDS-C60 (2012), MDS-L08 (2012), MDS-L16 (2012), MDS-L20 (2012), MDS-X08 (2012), MDS-X16 (2012), MDS-X20 (2012), MDS-X32 (2012), MDS-X40 (2012), MDS-X50 (2012), MDSL, MDSX (800-2000), MDSX (3200-5000)
	Federal Pioneer	NA, NB, NBH, NC
	Siemens	HEG, NEG, HMG, HNG, HPG, LMG, LNG, LPG, NMG, NNG NPG
	Square-D	DG 400, DG 600, DJ 400, DJ 600, DL 400, DL 600
LVCB - IEC	ABB	S8H, S8V
	Allen-Bradley	140U-D (0.5-1A), 140U-D (2-6A), 140U-D (8-10A), 140U-D (12-20A), 140U-D (25-30A)
	GE Power Controls	EP60, EP100, EP250, EP100, EP250 (6-25A), EP250 (32-40A), EP250 (50-63A), EP250M (6-25A), EP250M (40A), EP250M (63A), FD63C, FD63E, FD63H, FD63L, FD63N, FD63S, FD63L (160A), FD63L (20-125A), FD63N, FD63S, FD160C, FD160E, FD160H, FD160L, FD160L (160A), FD160L (20-125A), FD160N, FD160S, FE160H, FE160L, FE160N, FE250H, FE250L, FE250N, FE250V
	Merlin Gerin	C120H
	Square-D	DG 400, DG 600, DJ 400, DJ 600, DL 400, DL 600
	Telemecanique	GV2 L07, GV2 L08, GV2 L10, GV2 L14, GV2



		L16, GV2 L20, GV2 L22, GV2 L32, GV2 LE07, GV2 LE08, GV2 LE10, GV2 LE14, GV2 LE20, GV2 LE22, GV2 LE32, GV2 M07, GV2 M08, GV2 M10, GV2 M14, GV2 M16, GV2 M20, GV2 M21, GV2 M22, GV2 ME 07, GV2 ME 08, GV2 ME 10, GV2 ME 14, GV2 ME 16, GV2 ME 20, GV2 ME 21, GV2 ME 22, GV2 ME 32, GV2 P07, GV2 P08, GV2 P10, GV2 P14, GV2 P16, GV2 P20, GV2 P21, GV2 P22, GV2 P32
	Terasaki	E125-NJ, E250-NJ, E400-NJ, H125-NJ, H160-NJ, H250-NJ, H400-NJ, L125-NJ, L160-NJ, L250-NJ, L400-NJ, S125-GJ, , E250-NJ, E400-NJ, H125-NJ, H160-NJ, H250-NJ, H400-NJ, L125-NJ, L160-NJ, L250-NJ, L400-NJ, S125-NF, S125-NJ, S125-GJ, S160-GJ, S160-NF, S160-NJ (20,32A), S160-NJ (50-160A), S400-CJ, S400-GJ, S400-NJ S250-GJ, S250-NJ
TM	Allen-Bradley	140U-K0 , 140U-K0 (DC), 140U-K3 , 140U-K3 (DC), 140U-K6 , 140U-K6 (DC)
	Carling Technologies	F-Series 11-Ultrashort, F-Series 12-Short, F-Series 14-Medium, F-Series 16-Long,
	Cutler-Hammer	CHH, EC, EHC, FC, GDB, GHQ, HGHB (1 Pole), HGHC (1 Pole),
	Federal Pacific	NFJ
	Federal Pioneer	NA (2P), NA (3P), NC (2P)
	GE Power Controls	Elfa Plus B Curve, Elfa Plus C Curve, Elfa Plus D Curve
	Merlin Gerin	C120H-B curve (IEC), C120H-C curve (IEC), C120H-D curve (IEC)
	Siemens	525 (MG frame), 525 (MG frame) (DC), 525 (NG frame), 525 (NG frame) (DC), 525 (PG frame), 525 (PG frame) (DC), EG
	Telemecanique	GV2 L (3P), GV2 LE (3P), GV2 M (3P), GV2 ME (3P), GV2 P (3P)
	Terasaki	E125-NJ, E125-NJ (DC), E400-NJ, E400-NJ (DC), H125-NJ, H125-NJ (DC), H160-NJ, H160-NJ (DC), H400-NJ, H400-NJ (DC), S125-NF, S160-NF, S160-NJ, S160-NJ (DC)
LVSST	ABB	SACE PR212
	Cutler Hammer	FDE, RMS 520 Series, RMS1150(lt2), RMS1150(l4t)
	Mitsubishi	WB, WM, WS
	satinAMERICAN	ETC-12 (H1/N1), ETC-12 (H2), ETC-12 (ST disabled)
	Siemens	ETU 545 (DG frame), ETU 545 (FG frame), ETU 545 (LG frame), ETU 545 (MG frame), ETU 545 (NG frame), ETU 545 (PG frame), ETU 576 (DG



		frame), ETU 576 (FG frame), ETU 576 (JG frame), ETU 576 (LG frame), ETU 576 (MG frame), ETU 576 (NG frame), ETU 576 (PG frame)
	Square-D	GFM100FA, GFM100FI, GFM250

	MFR	Model
Fuse - ANSI	ABB	DO-III 143G, DO-III 144G, DO-III 145G
	Bussman	DFJ, FRN-R(8/00), FWA, FWH, FWJ 35-2000A, FWP, FWX
	Cutler-Hammer	LFB Current Limiter
	Edison	LCL, LCU
	Gould Shawmut (Ferraz)	A100C Type 30, A150C Type 10, A150C Type 20, A150C Type 40, A150C Type 50, A200C Type 10, A200C Type 50, A250C Type 10, A250C Type 30, A250C Type 50, A300C Type 10, A300C Type 20, A300C Type 60, A430C Type 15, A430C Type 70, A430C Type 75, A550C Type 15, A550C Type 70, A550C Type 75, PSC aR Sizes 70 (350A), PSC aR Sizes 70 (63A-315A), PSC aR Sizes 71 (160A-500A), PSC aR Sizes 71 (500A-630A), PSC aR Sizes 72 (280A-630A), PSC aR Sizes 72 (630A-800A), PSC aR Sizes 73 (1000A-1400A), PSC aR Sizes 73 (1400A), PSC aR Sizes 73 (315A-900A), PSC aR Sizes 73 (800A), PSC aR Sizes 73 (900A-1100A)
	Hi-Tech Fuses Inc	FLR, MCLF, Trans-Guard OS Shorty
	Littelfuse	JLLN, JLLS, JTD ID
	Mersen	A240R, A100C - Type 30, A150C - Type 10, A150C - Type 20, A150C - Type 40, A150C - Type 50, A200C - Type 10, A200C - Type 50, A250C - Type 10, A250C - Type 30, A250C - Type 50, A300C - Type 10, A300C - Type 20, A300C - Type 60, A430C - Type 15, A430C - Type 70, A430C - Type 75, A550C - Type 15, A550C - Type 70, A550C - Type 75
	Southern States	AF
Fuse - IEC	Areva	FDw(T) 7.2, FDw(T) 712, FDw(T) 17.5-x-2, FDw(T) 17.5-x-3, FDw(T) 17.5-x-4, FDw(T) 24, FDw(T) 36
	Bussman	7.2TDLSJ, 7.2TFLSJ, 12TDLEJ, 12THLEJ, 12TKLEJ, 12TXLEJ, 17.5TDLSJ, 17.5TDMEJ, 17.5TFLSJ, 17.5THMEJ, 17.5TKMEJ, 24TDMEJ, 24TFMEJ, 24THMEJ, 24TXMEJ, AAO, AD, BAO, BC, BD, CD, CDN, CDS, CEO, DD, DEO, ED, EF, EFS, ESD, FEE, FF, FG, FMM, GF, GG, GH, NITD, NSD, OSD, PON
	Driescher	H 220, H221
	GE Power Controls	HRC-400 Series, HRC-Standard, HRC-Type NS,



		ES,XS HRC-Type OS, HRC-Type SS, NH-General Purpose, NH-Motor Starting, Nit and Net
	Gould Shawmut (Ferraz)	NH (Size 0), NH (Size 00), NH (Size 000), NH (Size 1), NH (Size 2), NH (Size 3), PSC aR Sizes 70 (350A), PSC aR Sizes 70 (63A-250A), PSC aR Sizes 70 (280A-315A), PSC aR Sizes 71 (160A-450A), PSC aR Sizes 71 (500A-630A), PSC aR Sizes 72 (280A-630A), PSC aR Sizes 72 (630A-800A), PSC aR Sizes 72 (700A-800A), PSC aR Sizes 73 (1000A-1400A), PSC aR Sizes 73 (1100A), PSC aR Sizes 73 (1400A), PSC aR Sizes 73 (315A-800A), PSC aR Sizes 73 (700A-900A), PSC aR Sizes 73 (800A), PSC aR Sizes 73 (900A-1100A), PSC aR 2x72(1250A-1400A), PSC aR 2x72 (1600A), PSC aR 2x72 (630A-1100A), PSC aR 2x73 (1400A-1800A), PSC aR 2x73 (2000A), PSC aR 2x73 (2200A), PSC aR 2x73 (2500A), PSC aR 2x73 (2800A), PSC aR 2x73 (800A-1250A)
	Hitachi	FPLS
	L&T	HF, HN (Size 0), HN (Size 00), HN (Size 000), HN (Size 1), HN (Size 2), HN (Size 3)
	Merlin Gerin	NS80H, MA
	Mitsubishi	AE630 -SW, AE1000-SW, AE1250-SW, AE1600-SW, AE2000-SW, AE2000-SWA, AE2500-SW, AE3200-SW, AE4000-SW, AE4000-SWA, AE5000-SW, AE6300-SW

	MFR	Model
Relay	ABB	DPU



System Requirements

Operating System (32-bit or 64-bit)

Microsoft® Windows® 8 (Standard, Professional)
Microsoft Windows 7 (Home Premium, Professional, Ultimate) (SP 1)
Microsoft Windows Vista (Home Premium, Business, Enterprise) (SP 2)
Microsoft Windows XP (Home Edition, Professional) (SP 3)
Microsoft Server 2008 R2
Microsoft Server 2008
Microsoft Server 2003 R2 (SP 2)
Microsoft Server 2003 (SP 2)

Other Software Requirements

Internet Explorer® 5.01 or higher (or minimum version level specified by the Operating System)
Microsoft .NET Framework v3.5 (SP 1)
Microsoft SQL Server Compact 3.5 (SP2)

PC Configuration Requirements

USB port (if stand-alone licensing required)
Ethernet port w/ network access (if network licensing required)
DVD Drive
10 to 80 GB hard disk space (based on project size, number of buses)
19" monitors recommended (dual monitors highly recommended)
Recommended display resolution -1280 X 1024

Recommended Hardware Requirements

100 Bus Projects

Intel Dual/Quad core – 2.0 GHz or better (or equivalent)
2 GB of RAM

500 Bus Projects

Intel Dual/Quad core – 2.0 GHz or better (or equivalent)
4 GB of RAM

1,000 Bus Projects

Intel Dual/Quad core – 3.0 GHz with Hyper-Threading & high speed bus (or equivalent)
8 GB of RAM (high-speed)
64-bit Operating System

10,000 Bus Projects and Higher

Intel Dual/Quad core – 3.0 GHz with Hyper-Threading & high speed bus (or equivalent)
12 GB RAM - (high-speed)
64-bit Operating System

ETAP 11.1.1

June 2012

ETAP is pleased to send you the enclosed ETAP 11.1.1 point release. ETAP 11.1.1 is a complete program and does not require any previous ETAP installation.

ETAP 11.1.1 will utilize the same 36-Digit Activation Code as provided with the ETAP 11 series release.

ETAP 11.1.1 Update

This point release is the latest in the ETAP 11 series and includes an important update to the earlier 11.1.0 release. ETAP 11.1.1 is issued as a fix to an incident detected in ETAP 11.1.0 release that is related to the Star – Protection Device Coordination module.

The elements inside Composite Networks become de-energized when a Composite Network is selected and a Star View (TCC) is generated. This problem does not affect Composite Motor or the data in the selected Composite Networks.

If this issue is detected in your project, ETAP 11.1.1 will automatically fix the problems with the disabled Composite Networks upon opening the project file.

The list of fixed Composite Networks is placed in a conversion log located in the converted project directory.

Note that in ETAP 11.1.0 the elements within the disabled Composite Networks were de-energized and thus ignored in network analysis. After the project conversion, it is recommended to review any study involving the listed disabled Composite Networks.

Library Additions

The following devices were added to ETAP 11.1.1

Device Type	Manufacturer	Model
Low Voltage Circuit Breakers	Cutler-Hammer	SBN-508, SBN-608, SBN-CO8, SBS-608, SBS-C08, SBN-512, SBN-612, SBN-C12, SBS-612, SBS-C12, SBS-E12, SBN-516, SBN-616, SBN-C16, SBS-616, SBS-C16, SBS-E16, SBN-620, SBN-C20, SBS-620, SBS-C20, SBS-E20, SBS-625, SBS-C25, SBS-E25, SBS-630, SBS-C30, SBS-E30, SBS-840, SBS-C40, SBS-E40, SBS-850, SBS-C50, SBS-E50, SBS-C60
	Hitachi	F-400R
	Moeller	NZMH4-AE1250, NZMH4-AE800
	Siemens	HMG, HNG, HPG, LMG, LNG, LPG, NMG, NNG, NPG
	Square-D	HJ, HL, JJ, JL
	Terasaki	E50-NF, E400-NF, S50-CF, S50-NF, E50-NF
Thermal Magnetic Trip Units (TM)	Hitachi	F-400R
	Siemens	525(MG frame), 525(NG frame), 525(PG frame)
Solid State Trip	Cutler-Hammer	RMS 1150/RMS520
	Moeller	AE1250, AE800
	Square-D	PowerPact H/J
Fuse	ANDELI	XRNT1
	GEC	DSL BX, DSSAX
	Bussmann	FRS-R
	Gould Shawmut (Ferraz)	HSJ
	Mersen	HSJ

System Requirements

Operating System (32-bit or 64-bit)

Microsoft® Windows® 7 (Home Premium, Professional, Ultimate) (SP 1)
Microsoft Windows Vista (Home Premium, Business, Enterprise) (SP 2)
Microsoft Windows XP (SP 3) Professional or Home Edition
Microsoft Server 2008
Microsoft Server 2008 R2
Microsoft Server 2003 (SP 2)
Microsoft Server 2003 R2 (SP 2)

Other Software Requirements

Internet Explorer 5.01 or higher (or minimum version level as specified by the Operating System in use)
Microsoft .NET Framework v3.5 (SP 1)
Microsoft SQL Server Compact 3.5 (SP1)

PC Configuration Requirements

USB port (if stand-alone licensing required)
Ethernet port w/ network access (if network licensing required)
DVD Drive
10 to 80 GB hard disk space (based on project size, number of buses)
19" monitors recommended (dual monitors highly recommended)
Recommended display resolution -1280 X 1024

Recommended Hardware Requirements

100 Bus Projects

Intel Dual/Quad core – 2.0 GHz or better (or equivalent)
2 GB of RAM

500 Bus Projects

Intel Dual/Quad core – 2.0 GHz or better (or equivalent)
4 GB of RAM

1,000 Bus Projects

Intel Dual/Quad core – 3.0 GHz with Hyper-Threading Technology with high speed bus (or equivalent)
8 GB of RAM (high-speed)
64-bit Operating System

10,000 Bus Projects and Higher

Intel Dual/Quad core – 3.0 GHz with Hyper-Threading with high speed system bus (or equivalent)
12 GB RAM - (high-speed)
64-bit Operating System

ETAP 11.1

January 2012

The OTI Research & Development Team is pleased to offer you the enclosed ETAP 11.1 release. ETAP 11.1 is a complete program and does not require any previous ETAP installation.

The first time you run ETAP 11.1, you will need to enter the 36-Digit Activation Code as provided on the back cover of the ETAP 11.1 installation DVD.

This point release expands on the current release by offering multiple language support. ETAP 11.1 is completely localized in six languages: English, Spanish, Chinese, Japanese, Portuguese, and Russian.

This release offers new and enhanced features including:

New Modules

- DC Arc Flash Analysis

Enhanced Features

- Conversion tool from Dapper[®] PTW32 versions 6.0 & 6.5
- Import from PSS[®]E version 29 & 30

Enhanced Libraries

- Updated cable library based on NEC[®] 2008
- New cable library based on British Std. 7671

DC Arc Flash Analysis

The ETAP DC Arc Flash analysis module uses several methods to determine the level of incident energy which can be generated by different direct-current electric circuits. The program is fully integrated into the ETAP DC Short-Circuit calculation program which has been an industry standard for the analysis of DC equipment faults for many years. The program can be used to determine the arc flash energy for industrial, nuclear, data centers, electrochemical, petrochemical and any other DC electrical applications.

The DC arc flash incident energy and arc flash boundaries are determined based on the equations and methodology presented in the following documents

- National Fire Protection Agency (NFPA) 70E-2012
- DC Arc Models and Incident Energy Calculations Paper No. PCIC-2009-07
- Arc Flash Calculation for Exposures to DC Systems, IEEE Transactions on Industry Applications Vol. 46 NO. 6 November / December 2010

Features

- Incident Energy & Shock Protection Boundary Calculations
- Maximum Power, Stokes & Oppenlander, Paukert Methods
- NFPA 70E 2012 Compliant
- Integrated DC Short Circuit Analysis Software
- DC Arc Flash Result Analyzer
- Incident Energy Plots
- DC Arc Flash Labels
- Integrated DC Protective Device Library
- Determine Fault Clearing Time from DC protective devices
- MS Excel® Export & Report

Data Exchange

ETAP 11.1 brings a new import utility that allows for the automatic conversion of projects created in SKM. This feature is included as a part of the base module. This data exchange tool allows for direct import of SKM Dapper® PTW32 versions 6.0 & 6.5. For converting projects in earlier PTW32 versions, first open and save the projects under ver. 6.0 or 6.5

Features

- Converts Dapper® PTW32 versions 6.0 & 6.5
- Automatic, one click conversion of SKM Dapper projects
- One-line diagram layout conversion per the original project drawing
- Support for multiple one-Line drawing files
- Conversion of AC & DC networks

ETAP Feature enhancements to SKM one-line diagram

- Create nested one-line diagrams by adding composite networks
- Current Transformer (CT) elements automatically generated during conversion, when relays are found
- Add equipment cables to motors to remove the need for unnecessary buses

Conversion of SKM Captor® will be offered in subsequent ETAP release.

ETAP and ETAP Real Time are trademarks of Operation Technology, Inc. All other trademarks, product names and/or logos are the property of their respective holders.

This document is confidential and proprietary to ETAP/Operation Technology, Inc. and may not be reproduced, published or disclosed to others without the written authorization of ETAP/Operation Technology, Inc., 17 Goodyear, Suite 100, Irvine, CA 92618, USA. © 2012 by ETAP/Operation Technology, Inc. All Rights Reserved.

Library Additions

The following devices were added to the ETAP 11.1.

Device Type	Manufacturer	Model
Low Voltage Circuit Breakers	Siemens	NGB, NGG
Thermal Magnetic Trip Units (TM)	Siemens	NGB, NGG
Fuse	Bussman	JHC, JKS (10/02), KRP-C-SP (5/01), MV DIN-ADOSJ, MV DIN-TDLEJ, MV DIN-TDLSJ, MV DIN-TDMEJ, MV DIN-TDQSJ, MV DIN-TFLSJ, MV DIN-TFMEJ, MV DIN-TFMSJ, MV DIN-TFQSJ, MV DIN-THLEJ, MV DIN-THMEJ, MV DIN-TKLEJ, MV DIN-TKMEJ, MV DIN-TXLEJ, MV DIN-TXMEJ, MV DIN-TXQEJ, MV DIN-WFOSJ
	Edison	ECNR, ECSR
	Gould Shawmut (Ferraz)	CS-3 A825X
HVCB	Alstom	PKG

Cable Library Additions

ETAP 11.1 has been updated with extensive cable library additions.

Source	Unit System	Freq. (Hz)	Cond. Type	Instal.	kV	% Class	#/C	Insulation
NEC	English	50	AL	Mag.	0.6	100	3/C	Rubber
NEC	English	50	AL	Mag.	0.6	100	1/C	Rubber 2
NEC	English	50	AL	Non-Mag.	0.6	100	3/C	Rubber
NEC	English	50	AL	Non-Mag.	0.6	100	1/C	Rubber 2
NEC	English	50	CU	Mag.	0.6	100	3/C	Rubber
NEC	English	50	CU	Mag.	0.6	100	1/C	Rubber 2
NEC	English	50	CU	Non-Mag.	0.6	100	1/C	Rubber 2
NEC	English	60	AL	Mag.	0.6	100	3/C	Rubber
NEC	English	60	AL	Mag.	0.6	100	1/C	Rubber 2
NEC	English	60	AL	Mag.	1	100	3/C	Rubber
NEC	English	60	AL	Mag.	1	100	1/C	Rubber 2

Source	Unit System	Freq. (Hz)	Cond. Type	Instal.	kV	% Class	#/C	Insulation
NEC	English	60	AL	Mag.	5	133	3/C	Rubber
NEC	English	60	AL	Mag.	15	100	3/C	Rubber
NEC	English	60	AL	Non-Mag.	0.6	100	3/C	Rubber
NEC	English	60	AL	Non-Mag.	0.6	100	1/C	Rubber 2
NEC	English	60	AL	Non-Mag.	1	100	3/C	Rubber
NEC	English	60	AL	Non-Mag.	1	100	1/C	Rubber 2
NEC	English	60	AL	Non-Mag.	5	133	3/C	Rubber
NEC	English	60	AL	Non-Mag.	15	100	3/C	Rubber
NEC	English	60	CU	Mag.	0.6	100	3/C	Rubber
NEC	English	60	CU	Mag.	0.6	100	1/C	Rubber 2
NEC	English	60	CU	Mag.	1	100	3/C	Rubber
NEC	English	60	CU	Mag.	1	100	1/C	Rubber 2
NEC	English	60	CU	Mag.	5	100	3/C	Rubber
NEC	English	60	CU	Mag.	5	133	3/C	Rubber
NEC	English	60	CU	Mag.	15	100	3/C	Rubber
NEC	English	60	CU	Mag.	15	100	3/C	Rubber
NEC	English	60	CU	Mag.	15	133	3/C	Rubber
NEC	English	60	CU	Non-Mag.	0.6	100	3/C	Rubber
NEC	English	60	CU	Non-Mag.	0.6	100	1/C	Rubber 2
NEC	English	60	CU	Non-Mag.	1	100	3/C	Rubber
NEC	English	60	CU	Non-Mag.	1	100	1/C	Rubber 2
NEC	English	60	CU	Non-Mag.	5	133	3/C	Rubber
NEC	English	60	CU	Non-Mag.	15	100	3/C	Rubber
Southwire-PV	English	60	CU	Non-Mag.	0.6	100	1/C	XLPE
Southwire-PV	English	60	CU	Non-Mag.	2	100	1/C	XLPE
Southwire-PV	English	60	AL	Non-Mag.	2	100	1/C	XLPE

Source	Unit System	Freq. (Hz)	Cond. Type	Instal.	kV	% Class	#/C	Insulation
Southwire-PV	English	60	CU	Non-Mag.	0.6	100	1/C	USE2
Southwire-PV	English	60	CU	Non-Mag.	2	100	1/C	USE2
Southwire-PV	English	60	AL	Non-Mag.	2	100	1/C	USE2
Southwire-PV	English	60	CU	Non-Mag.	0.6	100	1/C	RHW2
Southwire-PV	English	60	CU	Non-Mag.	2	100	1/C	RHW2
Southwire-PV	English	60	AL	Non-Mag.	2	100	1/C	RHW2
NEC	English	60	CU	Magn.	0.6	100	1/C	UF
NEC	English	60	CU	Magn.	0.6	100	1/C	RHW
NEC	English	60	CU	Magn.	0.6	100	1/C	THHW
NEC	English	60	CU	Magn.	0.6	100	1/C	THW
NEC	English	60	CU	Magn.	0.6	100	1/C	THWN
NEC	English	60	CU	Magn.	0.6	100	1/C	USE
NEC	English	60	CU	Magn.	0.6	100	1/C	XHHW
NEC	English	60	CU	Magn.	0.6	100	1/C	ZW
NEC	English	60	CU	Magn.	0.6	100	1/C	RHH
NEC	English	60	CU	Magn.	0.6	100	1/C	RHW
NEC	English	60	CU	Magn.	0.6	100	1/C	THHN
NEC	English	60	CU	Magn.	0.6	100	1/C	THWN
NEC	English	60	CU	Magn.	0.6	100	3/C	XHHW
NEC	English	60	CU	Magn.	0.6	100	1/C	TW
NEC	English	60	CU	Magn.	0.6	100	1/C	UF
NEC	English	60	CU	Magn.	0.6	100	1/C	RHW
NEC	English	60	CU	Magn.	0.6	100	1/C	THHW
NEC	English	60	CU	Magn.	0.6	100	1/C	THW
NEC	English	60	CU	Magn.	0.6	100	1/C	THWN
NEC	English	60	CU	Magn.	0.6	100	1/C	USE
NEC	English	60	CU	Magn.	0.6	100	1/C	XHHW
NEC	English	60	CU	Magn.	0.6	100	1/C	ZW
NEC	English	60	CU	Magn.	0.6	100	1/C	FEP
NEC	English	60	CU	Magn.	0.6	100	1/C	FEPB

This document is confidential and proprietary to ETAP/Operation Technology, Inc. and may not be reproduced, published or disclosed to others without the written authorization of ETAP/Operation Technology, Inc., 17 Goodyear, Suite 100, Irvine, CA 92618, USA. © 2012 by ETAP/Operation Technology, Inc. All Rights Reserved.

Source	Unit System	Freq. (Hz)	Cond. Type	Instal.	kV	% Class	#/C	Insulation
NEC	English	60	CU	Magn.	0.6	100	1/C	MI
NEC	English	60	CU	Magn.	0.6	100	1/C	RHH
NEC	English	60	CU	Magn.	0.6	100	1/C	RHW2
NEC	English	60	CU	Magn.	0.6	100	1/C	SA
NEC	English	60	CU	Magn.	0.6	100	1/C	SIS
NEC	English	60	CU	Magn.	0.6	100	1/C	TBS
NEC	English	60	CU	Magn.	0.6	100	1/C	THHN
NEC	English	60	CU	Magn.	0.6	100	1/C	THHW
NEC	English	60	CU	Magn.	0.6	100	1/C	THW2
NEC	English	60	CU	Magn.	0.6	100	1/C	THWN2
NEC	English	60	CU	Magn.	0.6	100	1/C	USE2
NEC	English	60	CU	Magn.	0.6	100	1/C	XHH
NEC	English	60	CU	Magn.	0.6	100	1/C	XHHW
NEC	English	60	CU	Magn.	0.6	100	1/C	XHHW2
NEC	English	60	CU	Magn.	0.6	100	3/C	XHHW2
NEC	English	60	CU	Magn.	0.6	100	1/C	ZW2

System Requirements

Operating System (32-bit or 64-bit)

Microsoft® Windows® 7 (Home Premium, Professional, Ultimate) (SP 1)
Microsoft Windows Vista (Home Premium, Business, Enterprise) (SP 2)
Microsoft Windows XP (SP 3) Professional or Home Edition
Microsoft Server 2008
Microsoft Server 2008 R2
Microsoft Server 2003 (SP 2)
Microsoft Server 2003 R2 (SP 2)

Other Software Requirements

Internet Explorer 5.01 or higher (or minimum version level as specified by the Operating System in use)
Microsoft .NET Framework v3.5 (SP 1)
Microsoft SQL Server Compact 3.5 (SP1)

PC Configuration Requirements

USB port (if stand-alone licensing required)
Ethernet port w/ network access (if network licensing required)
DVD Drive
10 to 80 GB hard disk space (based on project size, number of buses)
19" monitors recommended (dual monitors highly recommended)
Recommended display resolution -1280 X 1024

Recommended Hardware Requirements

100 Bus Projects

Intel Dual/Quad core – 2.0 GHz or better (or equivalent)
2 GB of RAM

500 Bus Projects

Intel Dual/Quad core – 2.0 GHz or better (or equivalent)
4 GB of RAM

1,000 Bus Projects

Intel Dual/Quad core – 3.0 GHz with Hyper-Threading Technology with high speed bus (or equivalent)
8 GB of RAM (high-speed)
64-bit Operating System

10,000 Bus Projects and Higher

Intel Dual/Quad core – 3.0 GHz with Hyper-Threading with high speed system bus (or equivalent)
12 GB RAM - (high-speed)
64-bit Operating System

ETAP 11.0

September 2011

The OTI Research & Development Team is pleased to offer you the enclosed ETAP 11.0 release. ETAP 11 is a complete program and does not require any previous ETAP installation.

This release offers rule-based, automated design and analysis tools that enable engineers and managers to significantly increase their productivity and reduce the amount of design and review man-hours.

ETAP 11 represents our continued commitment to provide the analytical and operation software tools for design and development of power systems now, and energy technologies for tomorrow.

New Features

- Data Manager
- Project Merge

New Elements

- Bus Duct
- Single Phase Source
- Photovoltaic Array
- Switching Devices
- Open-Delta Transformer
- Variable Frequency Drive - VFD

New Modules

- User-Defined Dynamic Model – UDM
- Protective Conductor Sizing – IEC/BS
- Electric Shock Calculation – IEC/BS

Enhanced Elements

- Induction Machine
- Transformer
- Uninterruptable Power Supply – UPS
- Wind Turbine Generator – WTG

Enhanced Modules

- Multi-Dimensional Database
- Data Exchange – Data X
- Theme Manager
- Protective Device Coordination – Star
- Arc Flash Analysis
- Underground Raceway System
- Cable System
- Cable Ampacity & Sizing – IEEE/NEC
- Cable Ampacity & Sizing – IEC/BS
- Load Flow
- Unbalanced Load Flow
- Motor Acceleration
- Harmonics
- Transient Stability
- Power System Monitoring & Simulation
- Event Playback
- Intelligent Fast Load Shedding
- Interchange Transaction Scheduling

Enhanced Libraries

- Relay
- LVCB + trip unit



Below is a detailed list of new features and capabilities of ETAP 11.

New Features

Data Manager

- View & edit Base & Revisions Data differences
- View equipment property differences
- Display & filter study data
- Graphical management of data

Project Merge

- Multi-user management of project merge
- Parallel ETAP project development
- Self-contained snapshots of the parent & branch projects

New Elements

Bus Duct

- Graphical representation on the One-Line Diagram
- Bus duct length, construction type, & material

Single Phase Source

- 1-phase power grid modeling
- 1-phase inverter modeling

Photovoltaic Array

- Performance adjustment coefficients
- Solar farm modeling
- Solar irradiance based on location & time
- AC & DC system analysis
- Inverter dynamic modeling & operation modes
- Maximum Peak Power Tracking (MPPT)
- Extensive Manufacturer/Model library
- P-V & I-V curves

Switching Devices

- Safety ground switch
- Integrated operation with Switching Management System
- Supervisory control for real-time switching operation



Variable Frequency Drive - VFD

- Multi-input connection for 6-24 pulse
- Sub-system modeling between VFD & motor
- Rectifier & inverter control models
- Output voltage & frequency control
- Frequency dependent modeling of sub-system
- Adjustable speed drive operation
- Motor acceleration control schemes
- Bypass switch for soft starter operation
- Input PF control

New Modules

User-Defined Dynamic Model - UDM

- Graphical model builder
- Library of pre-defined UDM models to create more complex models
- Compile & test directly from the UDM builder
- Control element toolbars including transfer blocks, input ports, output ports, etc.
- Automatic UDM links to components
- Import & Export to Simulink models
- Create & edit models for Exciter, Governor, Power System Stabilizer, & Lumped Load

Protective Conductor Sizing - IEC/BS

- BS 7671, IEC 60364-5-54
- PE thermal requirements & sizing
- Calculated or user-defined fault current & fault clearing time
- Reports in Crystal Reports & Excel
- Consider leakage current

Electric Shock Calculation - IEC/BS

- BS 7671, IEC 60364-4-41, EN 50122
- TN-C, TN-S, TN-C-S, TT, & IT Earthing types
- Electric shock requirements
- Loop impedance & current calculation
- Touch voltage calculation & evaluation
- Consider resistance to Ground/Earth
- GFCI/RCCB protection
- Reports in Crystal Reports & Excel



Enhanced Elements

Induction Machine

- PF & EFF at no-load & over-load conditions
- Locked-Rotor current based on NEMA MG1 Code Letter
- Option to calculate X_d'' & X_d' based on machine time constant

Transformer

- Open-Delta transformer
- Three 1-phase transformer
- MVA rating based on first & second stage cooling
- Option to display Vector Group

Uninterruptable Power Supply - UPS

- Parallel UPS connection modeling
- Option to control input PF
- Bypass switch modeling

Wind Turbine Generator - WTG

- WTG Manufacturer / Model library
- New WTG & control models for WECC type 1, 2, 3, & 4

Enhanced Modules

Multi-Dimension Database

- Lock & unlock element properties
- 16 States to track equipment conditions
- Local SQL server connectivity

Data Exchange - DataX

- Bi-directional Excel data exchange
- Load Ticket for induction machines
- ArcGIS handling of 1-phase systems
- PSS/E Raw data import
- ETAP-SPEL interface



Theme Manager

- Display color coding based on:
 - User-defined
 - Voltage level
 - Area
 - Grounding (Solid, Low-Z, High-Z, Un-Grounded)
 - Earthing (TT, TN, IT, NEC, earthing elements)
- Display faulted buses by symbol or color

Protective Device Coordination - Star

- Automatic detection of protection zones
- Automatic selection of coordination paths
- Protection & coordination zone viewer
- Combine / Integrate multiple device curves
- Ground & Neutral conductors damage curves
- Cumulative Transformer Inrush current
- Enhanced Plot Options

AC Arc Flash Analysis

- Sequence-of-Operation viewer
- Primary protective device identified
- Current Limiting Fuse (CLF) modeling based on:
 - IEEE 1584 equations (Class L & RK1)
 - Peak let-through curves
 - TCC Curve method
- LV transformer arc flash limit based on impedance, voltage & current
- Incident Energy plots for I_a & I_{bf}
- Enhanced display of results on the one-line diagram

DC Arc Flash Analysis

- DC arc flash calculation based on:
 - Maximum Power
 - Stokes & Oppenlander
 - Paukert
- Arc Flash Result Analyzer
- Arc Flash labels
- Incident Energy plots



Underground Raceway System

- Intelligent rule-based alignment & spacing tools
- Automatic conduit distribution & spacing
- Uniform & non-uniform conduit arrangements
- Utilize custom, NEC, or standard IEEE rule-based spacing
- Wizard for creating raceways based on rule-book

Cable System

- Cable Library with neutral, grounding/ protective conductor (PE)
- Add auxiliary neutral & PE conductors to cables
- Damage curve for neutral & PE conductors

Cable Ampacity & Sizing - IEEE/NEC

- IEEE 399, NEC 70, ICEA P54
- Cable sizing based on maximum or average phase operating current
- Ampacity & sizing reports in Crystal Reports & Excel
- Grounding conductor selection based on NEC
- Cable ampacity & sizing for U/G installation based on NEC

Cable Ampacity & Sizing - IEC/BS

- BS 7671, IEC 60364-5-52, IEC 60364-4-43
- Model Forms: BS & user-definable
- Cable sizing based on harmonic effect
- Typical overcurrent device curves
- Cable sizing based on maximum or average phase operating current
- Ampacity & sizing reports in Crystal Reports & Excel

Load Flow

- Auto-Run load flow based on system changes
- New toolbar to change & display result units
- Report voltage in %, kV, V
- Report power in MVA, kVA
- Isolated 1-phase source modeling

Unbalanced Load Flow

- Report voltage & power in multi-units
- Open-Delta transformer modeling
- Center-Tap transformer modeling
- Three 1-phase transformer modeling
- Isolated sub-systems with Voltage-Control source modeling
- Isolated 1-phase source & system modeling



Motor Acceleration

- VFD frequency control for motor starting
- User-defined frequency and Volt/Hz as functions of time
- Simulate voltage-boost effect at low frequency during starting
- Motor acceleration with VFD & soft starter

Harmonics

- VFD harmonic modeling
- Calculate & report I*TB (Balanced) & I*TR (Residual)
- UPS AC input & output modeling for harmonic orders
- PV Array modeling for harmonic orders

Transient Stability

- Lumped Load user-defined dynamic modeling
- New built-in IEEE standard exciters:
 - AC2A, AC7B, DC4B, ST1A, ST2A
- VFD dynamic modeling:
 - Rectifier, DC link, & inverter models
 - Voltage & frequency control models
- - Frequency control acceleration & operation
- UPS parallel operation modeling
- PV Array source modeling
- Inverter source modeling

Power System Monitoring & Simulation

- Generation reserve monitoring
- Multi-state breaker monitoring & control
- Large system handling optimization
- EPICS interface

Event Playback

- Playback of event views
- Historical alarm database

Intelligent Fast Load Shedding

- System islanding generator logic
- VFD load reduction control
- Automatic generation of transient study cases

Interchange Transaction Scheduling

THIS DOCUMENT IS CONFIDENTIAL AND PROPRIETARY TO OPERATION TECHNOLOGY, INC AND MAY NOT BE REPRODUCED PUBLISHED OR DISCLOSED TO OTHERS WITHOUT THE WRITTEN AUTHORIZATION OF OPERATION TECHNOLOGY, INC. COPYRIGHT © 2010 BY OPERATION TECHNOLOGY, INC.



- Transaction reports
- Fuel cost schedule reports

Real-Time

OPC Unified Architecture - UA Server

- Monitoring Console communication via WAN
- Thin client application
- Secured access control
- Interface to OPC UA & DA clients

Monitoring & Control Templates

- Thin client application for monitoring & control
- Customizable Web-based interfaces & technology
- Human Machine Interface (HMI) template library
- Web-based customizable HMI:
 - SCADA views
 - WPF dashboards
 - Trending & forecasting
 - Alarms & warnings
 - Control & supervision
 - Energy consumption monitoring
 - Reporting & logging
 - Geographical monitoring view

Command & Control

- Remote control - enable & disable commands
- Control inhibition based on system operational constraints
- Control inhibition based on switching operations

Data Center Power Management

- Power Panel monitoring
- Parallel UPS operation
- CO₂ & energy management system
- PDU monitoring & control templates



Library Additions

The following devices were added to the ETAP 11.0 library.

Device Type	Manufacturer	Model	
Relay	Cutler-Hammer	E777	
		E777-LR	
		E777-LR (CT)	
	GE Multilin	IAC-11A	
		IAC-11B	
		IAC-11C	
		IAC-11D	
		IAC-11E	
		IAC-11F	
		IAC-11H	
		IAC-12A	
		IAC-12B	
		IAC-12C	
		IAC-12D	
		GE Multilin	350
		GE Multilin	745
		Schweitzer	421
	GE Multilin	345	
	GE Multilin	339	
	Square-D	Sepam Series 40	
	Merlin Gerin	Sepam 40	
	ABB	REF 601	
	GE Multilin	BGFL	
	Federal Pioneer	TLR-3	
		ABB	RADHA
	Eaton	EDR-5000	
	Eaton	EDR-4000	
ABB	PCD		
Siemens	7SJ62		
Siemens	7SJ64		
Siemens	7SJ600		
Siemens	7SJ602		
Eaton	EDR-3000		
Mitsubishi	CMP2 - A02D2		
Mitsubishi	CMP1 - A02D1		
Mitsubishi	CMP1 - A02D2		



Device Type	Manufacturer	Model
Relay	Cutler-Hammer	FP-6000
	Cutler-Hammer	MD-3000
	Cutler-Hammer	IQ-500
	Cutler-Hammer	DP-300
	Schweitzer	700G
	Siemens	7SR11
	Siemens	7SR12
	GE Multilin	C70
	Siemens	7SJ80
	Siemens	7SK80
	Siemens	7UM61
	Siemens	7UM62
	Eaton	EMR-3000
	Eaton	ETR-3000
	GE Multilin	M60 (5.x)
	Startco Engineering Ltd.	SE-125
	CEE Relays	DTM 7033
	CEE Relays	ITG 7011
	CEE Relays	ITG 7111
	CEE Relays	ITH 7111
	CEE Relays	ITH 7521
	Siemens	7SD52/53
	Basler Electric	BE1-11f
		BE1-11i
		BE1-11g
		BE1-11m
	Siemens	7SJ511
	Square-D	Motor Logic (Class 9065)
	Schweitzer	300G
		300G (R328)
	Eaton	C440
		C440 (CT)
		XTOE
		XTOE (CT)
	Eaton	EMR-4000
		EGR-4000
	Schweitzer	751
	Eaton	C441
		C441 (CT)



Device Type	Manufacturer	Model
	Allen Bradley	825 SMM
Device Type	Manufacturer	Model
Relay	Allen Bradley	825 SMM (CT)
	Beckwith	M-3310
	Beckwith	M-3311
	Beckwith	M-3311A
LVCB + trip unit	Federal Pioneer	USD-6
		USD-20
		USR
	BS 7671	RCD (General Non-Delay)
		RCD (Delay'S')
	ABB	Ekip I (XT4)
		Ekip LS/I (XT4)
		Ekip LSI (Electronic XT4)
		Ekip LSI (Manual XT4)
		Ekip LSIG (Electronic XT4)
		Ekip LSIG (Manual XT4)
		Ekip I (X2)
		Ekip LS/I (XT2)
		Ekip LSI (Electronic XT2)
		Ekip LSI (Manual XT2)
		Ekip LSIG (Electronic XT2)
		Ekip LSIG (Manual XT2)
		Ekip G-LS/I (XT2)
		Ekip G-LS/I (XT4)
		Ekip G-LS/I (XT2)
		Ekip G-LS/I (XT4)
		XT1 16-63A TMD
		XT1 80-160A TMD
		XT2 160 TMA
		XT2 160 TMG
		XT3 250 TMD
		XT3 250 TMG
		XT4 250 TMA
		S 700 E
		S 700 K(16-50A)
		S 700 K(63-100A)
		S800-B, C, D

THIS DOCUMENT IS CONFIDENTIAL AND PROPRIETARY TO OPERATION TECHNOLOGY, INC AND MAY NOT BE REPRODUCED PUBLISHED OR DISCLOSED TO OTHERS WITHOUT THE WRITTEN AUTHORIZATION OF OPERATION TECHNOLOGY, INC. COPYRIGHT © 2010 BY OPERATION TECHNOLOGY, INC.



Device Type	Manufacturer	Model
		S800-B, C, D
		S800-B, C, D
		S800-B, C, D
LVCB + trip unit		S800-B, C, D
		S800-B, C, D, K, KM, UCB, UCK
		S800-B, C, D, K, KM, UCB, UCK
		S800-B, C, D, K, KM, UCB, UCK
		S800-B, C, D, K, KM, UCB, UCK
		S800-B, C, D, K, KM, UCB, UCK
		S 200-B, C, D, K, Z (AC, DC)
		S 200-B, C, D, K, Z (AC, DC)
		S 200-B, C, D, K, Z (AC, DC)
		S 200-B, C, D, K, Z (AC, DC)
		S 200-B, C, D, K, Z (AC, DC)
		S 200-B, C, D, K, Z (AC, DC)
		S 200-B, C, D, K, Z (AC, DC)
		S 200-B, C, D, K, Z (AC, DC)
		S 200-B, C, D, K, Z (AC, DC)
		S 200-B, C, D, K, Z (AC, DC)
		S 200-B, C, D, K, Z (AC, DC)
		T2 160-TMD, T2 160-TMD(125A), T2 160-TMD(160A), T2 160-TMG
		T2 160-TMD, T2 160-TMD(125A), T2 160-TMD(160A), T2 160-TMG
		T2 160-TMD, T2 160-TMD(125A), T2 160-TMD(160A), T2 160-TMG
		T2 160-TMD, T2 160-TMD(125A), T2 160-TMD(160A), T2 160-TMG
		T3 250-TMD, T3 250-TMG
		T3 250-TMD, T3 250-TMG



System Requirements

Operating System (32-bit or 64-bit)

Microsoft® Windows® 7 (Home Premium, Professional, Ultimate) (SP 1)
Microsoft Windows Vista (Home Premium, Business, Enterprise) (SP 2)
Microsoft Windows XP (SP 3) Professional or Home Edition
Microsoft Server 2008
Microsoft Server 2008 R2
Microsoft Server 2003 (SP 2)
Microsoft Server 2003 R2 (SP 2)

Other Software Requirements

Internet Explorer 5.01 or higher (or minimum version level as specified by the Operating System in use)
Microsoft .NET Framework v3.5 (SP 1)
Microsoft SQL Server Compact 3.5 (SP1)

PC Configuration Requirements

USB port (if stand-alone licensing required)
Ethernet port w/ network access (if network licensing required)
DVD Drive
10 to 80 GB hard disk space (based on project size, number of buses)
19" monitors recommended (dual monitors highly recommended)
Recommended display resolution -1280 X 1024

Recommended Hardware Requirements

100 Bus Projects

Intel Dual/Quad core – 2.0 GHz or better (or equivalent)
2 GB of RAM

500 Bus Projects

Intel Dual/Quad core – 2.0 GHz or better (or equivalent)
4 GB of RAM

1,000 Bus Projects

Intel Dual/Quad core – 3.0 GHz with Hyper-Threading Technology with high speed bus (or equivalent)
8 GB of RAM (high-speed)
64-bit Operating System

10,000 Bus Projects and Higher

Intel Dual/Quad core – 3.0 GHz with Hyper-Threading with high speed system bus (or equivalent)
12 GB RAM - (high-speed)
64-bit Operating System



ETAP 7.5.2

March 2011

The OTI Research & Development Team is pleased to offer you the enclosed ETAP 7.5.2 release. ETAP 7.5.2 is a complete program and does not require any previous ETAP installation.

This point release expands on the current release by offering multiple language support. ETAP 7.5.2 is completely localized in four languages plus translated output reports in six languages.

Starting with ETAP 7.5.2, ETAP will utilize the ETAP 1600-USB Security key. Please contact sales at sales@etap.com or 949-900-1000 for any key replacement. Please note ETAP will no longer support the black parallel keys and the blue USB-1410 keys.

The first time you run ETAP 7.5.2, you will need to enter the 36-Digit Activation Code as provided on the back cover of the ETAP 7.5.2 installation DVD.

	English	Spanish	Chinese	Japanese	Portuguese	German
Localized	✓	✓	✓	✓		
Output Reports	✓	✓	✓	✓	✓	✓

The latest edition of ETAP provides the following new enhancements:

Enhanced

- Exciters AC1, AC2, AC3, AC1A, AC8B and ST2
- Enhanced protective device libraries
- Enhanced PDE Components
- Enhanced Localized Chinese, Spanish and Japanese ETAP versions



ETAP 7.5.0

June 2010

The OTI Research & Development Team is pleased to offer you the enclosed ETAP 7.5.0 release. ETAP 7.5.0 is a complete program and does not require any previous ETAP installation.

This point release expands on the current release by offering multiple language support. ETAP 7.5.0 is completely localized in four languages plus translated output reports in six languages.

The first time you run ETAP 7.5.0, you will need to enter the 36-Digit Activation Code as provided on the back cover of the ETAP 7.5.0 installation DVD.

	English	Spanish	Chinese	Japanese	Portuguese	German
Localized	✓	✓	✓	✓		
Output Reports	✓	✓	✓	✓	✓	✓



Library Additions

The following devices were added to the ETAP 7.5.0 library for protective device coordination.

Device Type	Manufacturer	Model
Relays	Allen Bradley	193-EA, 193-ES
	Basler Electric	BE1-51 (1976), BE1-51/27 (1976)
	Comeca	Gemstart 5, Gemstart 5 (CT)
	L&T	MC31A
	Schweitzer	710 (R304)
	Solcon	MPS 3000
Thermal Magnetic Trip Units (TM)	General Electric	V-Line B, V-Line B (1P), V-Line B (2, 3P), V-Line C, V-Line C (1P), V-Line C (2, 3P), V-Line D
	Siemens	525 (MG Frame)
Fuse	Bussman	Cable Limiters-K Series, FRS-R (10/02)
	Cooper	Isolation Link , LCL
	Gould Shawmut (Ferraz)	HSRK
	Littelfuse	LDC



System Requirements

Operating System (32-bit or 64-bit)

- Microsoft® Windows® 7 (Home Premium, Professional, Ultimate)
- Microsoft® Windows Vista® (SP1) (Home Premium, Business, Enterprise)
- Microsoft® Windows® XP (SP3) (Professional or Home Edition)
- Microsoft® Server 2008 (SP2)
- Microsoft® Server 2003 R2 (SP2), Microsoft Server 2003 (SP2)

Software Requirements

- Microsoft® Internet Explorer® 5.01 or higher
(or minimum version level as specified by the operating system in use)
- Microsoft® .NET Framework v1.1 (SP1)
- Microsoft® .NET Framework v2.0 (SP1)

Hardware Requirements

- USB port (for stand-alone license)
- Ethernet port with network access (for network license)
- DVD drive
- 10 to 80 GB hard disk space (based on project size, number of buses)
Note: An additional 5 GB may be required if additional language support is installed
- 19" monitors recommended (dual monitors highly recommended)
- Minimum display resolution - 1024x768

Recommended Hardware

100 Bus Projects

- Intel® dual/quad core - 2.0 GHz (or equivalent)
- 2 GB RAM

500 Bus Projects

- Intel® dual/quad core - 2.0 GHz (or equivalent)
- 4 GB RAM

1,000 Bus Projects

- Intel® dual/quad core - 3.0 GHz with hyper-threading with high speed bus (or equivalent)
- 8 GB RAM (high speed)
- 64-bit operating system

10,000 Bus Projects and Higher

- Intel® dual/quad core - 3.0 GHz with hyper-threading with high speed bus (or equivalent)
- 12 GB RAM (high speed)
- 64-bit operating system



ETAP 7.1.0

November 2009

The OTI Research & Development Team is pleased to offer you the enclosed ETAP 7.1.0 release. ETAP 7.1.0 is a complete program and does not require any previous ETAP installation.

This point release is the latest in ETAP 7.0 series that delivers new design and analysis innovations and carries ETAP to a new level of advancement. ETAP 7.1.0 provides the platform upon which future ETAP innovations will follow. We recommend that you utilize this latest release in order to take advantage of the new features and capabilities.

The first time you run ETAP 7.1.0, you will need to enter the 36-Digit Activation Code as provided on the back cover of the ETAP 7.1.0 installation DVD.

For more information on this new release, please take a few moments to review the information below.

New Features

- *IEC Cable Sizing (IEC 60364-4-43)*
- *IEC Cable Ampacity (IEC 60364-5-52)*
- *Arc Flash Custom Labels*

Enhanced Modules

- *Short Circuit*
- *Arc Flash Analysis*
- *Transient Stability*
- *Data Exchange*
- *Control System Diagram*
- *Underground Thermal Analysis*

Enhanced Libraries

- *HVCB*
- *Relay*
- *LVCB*
- *LVSST*
- *Fuse*
- *Thermal Magnetic*
- *Harmonics*
- *Recloser*



New Features

Arc Flash Custom Labels

Many labels need to be customized according to different regulations or preferences (i.e., CSAZ462, NFPA 70E, NEC, ANSI Z535, etc.). ETAP 7.1.0 brings the capability to create and print custom arc flash labels based on different standards and safety requirements. Custom arc flash label templates can be generated using Microsoft Word® and linked to a Microsoft Excel® spreadsheet database to populate the label template with results from the arc flash calculation. Utilizing standard tools like Microsoft Excel and Word allows you to have greater flexibility in customizing labels for your facility in compliance with safety standards.

IEC Cable Ampacity – IEC 60364-5-52

The IEC cable ampacity calculations were added to allow the sizing process of cables per IEC 60364 (Low voltage electrical installations - Part 5-52: Selection and erection of electrical equipment - Wiring systems) for additional cable installation types, such as open / ventilated channels, wire mesh, architrave / window frame, and masonry.

IEC Cable Sizing – IEC 60364-4-43

Cable sizing based on IEC 60364-4-43 (Low-voltage electrical installations - Part 4-43: Protection for safety - Protection against overcurrent) has been added to the list of sizing standards supported by ETAP. IEC 60364-4-43 provides rules and regulations for inspecting and installing cables in electrical systems. Other guidelines like BS 7671 follow this new guideline closely, but with some differences.

Enhanced Modules

Short Circuit

The ETAP Short Circuit module has been enhanced to check the fused and un-fused low voltage circuit breaker rated kV per ANSI C37.11/ UL489 (Standard Requirements for Electrical Control for AC High Voltage Breakers Rated on a Symmetrical Basis). This enhancement allows you to easily verify that the correct voltage rating is used for your application.

Transient Stability

ETAP frequency-dependent modeling option for system component such as subtransient synchronous machines, induction machines (single- and double-cage) and networks are now included as a standard feature of the transient stability module. In the past, this option was available only with the purchase of Generator Start-Up module.

Open Format Excel

ETAP Open Format is used to import data from custom Microsoft Excel® load lists / tabulations to ETAP. Additional intelligence has been added to automatically handle blank rows, duplicate columns, etc. Open format also detects if a single voltage value has been included in the load list and can automatically consider that voltage for the bus and connected equipment.



SmartPlant Electrical Interface

The ETAP-SPEL Data Exchange Interface provides data synchronization between ETAP and Intergraph’s SmartPlant Electrical (SPEL). In addition to bringing in a list of new connections, ETAP now provides a list of modified connections based on changes being made in SPEL.

Control System Diagram (CSD)

ETAP has been enhanced to utilize the lower voltage value between two points in a voltage plot profile to pass to CSD to allow for more conservative results.

Underground Thermal Analysis

Additional materials have been added to existing cable layers in the ETAP cable editor and library. These additional materials include new cable armor, sheath and concentric wire options. These new materials are considered by Underground Thermal Analysis. Sheath/Armor options now include all of the following types:

Sheath/Armor Type

None	St Armor/45dg/20w	St Armor/45dg/80w	Cu Concentric Wire
Lead Sheath	St Armor/45dg/25w	St Armor/45dg/90w	Al Concentric Wire
Aluminum Sheath	St Armor/45dg/30w	St Armor/45dg/100w	Copper Sheath
St Armor/30dg/15w	St Armor/45dg/40w	St Armor/45dg/9999w	
St Armor/30dg/20w	St Armor/45dg/50w	Copper Armor	
St Armor/30dg/25w	St Armor/45dg/60w	Steel Armor	
St Armor/45dg/15w	St Armor/45dg/70w	Aluminum Armor	



Library Additions

The following devices were added to the ETAP 7.1.0 library for protective device coordination and harmonic analysis.

Device Type	Manufacturer	Model
High Voltage Circuit Breaker (HVCB)	Westinghouse	F-122,F-124-A, F-100, B-20-B, B-22-B, B-28-B, O-111-A, O-22-B, O-44-C, 150-CAF-500, 150-CA-1000, 150-CA-1500, 150-CA-2500, 345-CAF-500, 345-CA-1500, 345-CA-2500, 690-CA-3500, 690-CA-5000, F022B, 144-G-100, 144-G-250, 144-G-1000, 144-G-1500, 230-G-250, 230-G-500, 345-G-500, 345-G-1000, 345-G-1500, 345-G-2500, 460-G-500, 460-G-1500, 690-G-1000, 690-G-1500, 690-G-2500, 690-GM-5000, 2300-GW-5000, GO-5-A, GM-6-A, GM-6, GM-3, GM-5, GM-7, GM-5
Relays	ABB	HU, HU-1, HU-4, RADSS, COM, MICRO-51/FT, RADSS. RET 541, RET 543, RET 545, CO-4
	ALSTOM	CAG12C, CAG14, CAG34, CAG12
	Areva	P341, CAG12C, CAG14, CAG34, CTIGM15, CTUM15, CAG12
	Basler Electric	BE1-51A
	Cutler-Hammer	DT-3000, C396
	GE Multilin	BDD15B, BDD16B, BDD17B, BDD18B, BDD19B, BDD20B, MIB
	GEC	CAG14, CAG34
	Mitsubishi	CMP1-A02D1/2, CMP1-A02D2
	Moeller	ZB12-0,16, ZB12-0,24, ZB12-0,4, ZB12-0,6, ZB12-1, ZB12-1,6, ZB12,4, ZB12-4, ZB12-6, ZB12-10, ZB12-12, ZB12-16, ZB32-0,16, ZB32-0,24, ZB32-0,4, ZB32-0,6, ZB32-1, ZB32-1,6, ZB32,4, ZB32-4, ZB32-6, ZB32-10, ZB32-16, ZB32-24, ZB32-32
	Schneider Electric	Sepam Series 10
	Siemens	7SJ531
	Telemecanique	LR2 k
	Thytronic	NA10, NA60, SCK



Device Type	Manufacturer	Model
Low Voltage Circuit Breaker (LVCB)	Allen-Bradley	1492-GH
	Cutler-Hammer	LH, LHB-240V, LHB-600V, LS, LSB-240V, LSB-600V, FH-6, FS-2, FS-4, FS-6, JH, JS
	General Electric	EGF, EGH, EGS, EGX
	Hyundai	HBE (31 models), HBH (15 models), HBL (30 models), HBS (28 models), HBX (5Models), HBD (6 models), HBE (34 models), HBH (15 models), HBL (30 models), HBS (28 models), HBX (5Models), HBD (4 models), HBE (22 models), HBH (12 models), HBL (30 models), HBS (19 models), HBX (5Models)
	Merlin Gerin	C60H, C60L, C60N, CJ 400H, CJ 400L, CJ 400N
	Mitsubishi	NV250-CW, NV250-SW, NV400-CW, NV400-SW, NV630-CW, NV630-SW
	Siemens	NJG, HJG, LJG, NLG, HLG, LLG, NFG, HFG, LFG, NDG, HDG, LDG, 3RV13 21 (0.16-12.5A), 3RV13 21 (16-25A), 3RV13 31, 3RV13 41 (16-75A), 3RV13 41 (90-100A), 3RV13 42 (16-75A), 3RV13 42 (90-100A)
	Square D	QO, QO-VH
Thermal Magnetic (TM) Trip Units	Allen-Bradley	1492-GH
	Cutler-Hammer	LHE, LLE, LSE, FH, FS, JH, JS
	Merlin Gerin	C60N/H - D curve (IEC), C60N/H/L - C curve (IEC), CJ 400
	Mitsubishi	NV250, NV250, NV400-CW, NV400-SW, NV630, NV630
	Siemens	JG, LG, FG, DG, 3RV1321, 3RV1331, 3RV1341, 3RV1342
	Square D	QO, QO-VH
Low Voltage Solid State Trip (LVSST)	ABB	SACE PR112 (IEC)
	General Electric	Entelliguard



Device Type	Manufacturer	Model
Electronic Reclosers	S&C Electric Company	Vista (15.5kV), Vista (27kV), Vista (38kV), Vista (12kV), Vista (24kV), Vista (36kV)
Electronic Controller	S&C Electric Company	Vista (E Speed), Vista (K Speed), Vista (Main Interrupter), Vista (SEL Relay Curves), Vista (Tap Interrupter)

Device Type	Manufacturer	Model
Fuse	Bussmann	LPJ_SP (05/02), KRP-CL, LPJ_SP, SC, 155GXQSJD, 175GDMSJD, 175GFMSJD, 175GXMSJD, 175GXQSJD
	Cooper	Bay-O-Net (240-46)
	Delle	FD 3, FD 3M, FD 4, FD 5, FD 6, FD 7, FLR 6
	Edison	SDSLJ, SFLSJ, WKMSJ, SDMSJ, SFMSJ, SKMSJ, CDSC, CDNC, KOS, KON, PONC, JDL
	Fuji	HF-337, HF-337E, HF-338B, HF-338E, JR-30, SCF-6
	Gould Shawmut	A60X
	Juan Muller	NH000 - M000gG, NH00 - M00gG, NH1 - M1gG, NH2 - M2gG, NH3 - M3gG, NH4a - M4agG
	Kearney	Dual Element (DEWL)
	Littelfuse	KLPC, E-Rated Medium Voltage
	Siemens	3GD
	Std. DIN VDE 0636-2	gG

Library Type	Manufacturer	Model
Harmonic	Rockwell (Current Source)	PWM Rect
	Typical (Voltage Source)	G2/3P-FL_LL
		G2/3P-FL_LN
		G2/3P-NL_LL
		G2/3P-NL_LN
		G5/6P-FL_LL
		G5/6P-FL_LN
		G5/6P-NL_LL
		G5/6P-NL_LN



System Requirements

Operating System (32-bit or 64-bit)

- Microsoft® Windows® 7 (Professional, Ultimate)
- Microsoft® Windows Vista® (SP1) (Home Premium, Business, Enterprise)
- Microsoft® Windows® XP (SP3) (Professional or Home Edition)
- Microsoft® Server 2008 (SP2)
- Microsoft® Server 2003 R2 (SP2), Microsoft Server 2003 (SP2)

Software Requirements

- Microsoft® Internet Explorer® 5.01 or higher
(or minimum version level as specified by the operating system in use)
- Microsoft® .NET Framework v1.1 (SP1)
- Microsoft® .NET Framework v2.0 (SP1)

Hardware Requirements

- USB port (for stand-alone license)
- Ethernet port with network access (for network license)
- DVD drive
- 5 to 80 GB hard disk space (based on project size, number of buses)
- 19" monitors recommended (dual monitors highly recommended)
- Minimum display resolution - 1024x768

Recommended Hardware

100 Bus Projects

- Intel® dual/quad core - 2.0 GHz (or equivalent)
- 2 GB RAM

500 Bus Projects

- Intel® dual/quad core - 2.0 GHz (or equivalent)
- 4 GB RAM

1,000 Bus Projects

- Intel® dual/quad core - 3.0 GHz with hyper-threading with high speed bus (or equivalent)
- 8 GB RAM (high speed)
- 64-bit operating system

10,000 Bus Projects and Higher

- Intel® dual/quad core - 3.0 GHz with hyper-threading with high speed bus (or equivalent)
- 12 GB RAM (high speed)
- 64-bit operating system



ETAP 7.0.0

May 2009

The OTI Development Team is pleased to provide you with the enclosed ETAP 7.0.0 release. ETAP 7.0.0 is a complete program and does not require any previous ETAP installation.

ETAP 7.0.0 is a major release that delivers new design and analysis innovation to a new level of advancement and provides the platform upon which future ETAP innovation will follow. This version adds new powerful analysis modules and time-saving capabilities to the ETAP Suite. The new enhancements and analysis modules are still developed with mathematical precision using our Quality Assured Verification and Validation Procedure.

The first time you run ETAP 7.0.0, you will need to enter the 36-Digit Activation Code as provided on the ETAP 7.0.0 installation DVD.

For more information on this new release, please take a few moments to review the information below.

New Features

- *Arc Flash Analyzer*
- *Arc Flash Work Permit*
- *Arc Flash Data Sheet*
- *One-Line Templates*
- *Auto-Select*
- *Symbol Library*
- *Keyboard Shortcuts*

New Analysis Modules

- *Load Analyzer*
- *Single-Phase Arc Flash*

Enhanced Elements

- *Solid State Trip Devices*

Enhanced Modules

- *Base Package*
- *Load Flow*
- *Short-Circuit*
- *Arc Flash Analysis*
- *Transient Stability*
- *Harmonics*
- *Star Device Coordination/Selectivity*
- *Star Sequence of Operation*
- *Data Exchange*

Enhanced Libraries

- *Solid State Trip Devices*
- *Cable*
- *Transmission Line*
- *Relay*
- *Battery*



1. One-Line Diagram

Templates

This upgrade provides the ability to create and recall unlimited graphical templates. Create template versions of common electrical network configurations such as breaker-and-a-half, double-ended substation, and spot network. Utilize templates to quickly construct an entire electrical network faster than ever before with a single click. Create new online diagram templates or select from more 40 pre-built ANSI and IEC templates.

Features

- Create & Utilize unlimited one-line templates
- Share templates created by other ETAP engineers
- Use default project ID or template ID
- Use properties from default project or template
- Instant preview of templates

Auto Select

One of the new innovations to the One-Line Diagram is the inclusion of the Graphical Auto Selection tool. Graphical Auto Selection provides the capability to move the associated components with a simple mouse stroke (shortcut Alt+Click). For example, selecting a Motor Control Center (MCC) bus automatically selects the loads and protective devices connected to that bus. These related elements are automatically grouped for quicker one-line layouts.

Features

- Intelligent load & feeder selection designed for electrical systems
- Works with bus, branch, loads, & protective devices
- Auto-grouping & ungrouping

Symbol Library

Substitute default one-line diagram symbols with an alternative symbol set for individual device types. Need a SCADA look for your circuit breakers? Launch the symbol substitution tool and swap symbol sets with the press of a button. Symbol substitution allows you to store and recall the default symbols at any point in time.

Features

- Instant preview of alternative symbols
- Instantly create a new look on the one-line diagram
- New SCADA and IEC standard symbols

Keyboard Shortcuts

ETAP 7.0 includes a large array of keyboard shortcuts, which saves time and effort in creating and editing.



2. Arc Flash

ETAP 7.0 brings you new and enhanced capabilities which allow for faster and easier performance of arc flash hazard analysis. Identify and analyze high risk arc flash areas in your electrical system with greater flexibility by simulating various incident energy mitigation methods. Arc Flash is a completely integrated module that solves multiple scenarios to determine worst case incident energy levels and it also produces professional reports and high quality arc flash labels at a press of a button.

Features

- Automatic consideration of generator AC decay & decrement curve
- AC motor short-circuit current decay handling
- Time varying fault clearing time calculation short-circuit current decay
- Arc flash calculations for 3-phase & 1-phase panel / UPS systems
- Radial & multiple source system handling
- Extended search beyond the point of multiple upstream source
- Automatic or User-defined source protective device search algorithm option
- Modeling of differential relays, maintenance mode switches, & arc flash photo-sensors
- Zone Selective Interlock Protection (ZSIP) representation
- Three phase and single phase systems
- User-Interface for defining hazard categories (NFPA 70E 2000, 2004, & 2009) or customize based on your safety program requirements
- Generate IEEE 1584 & NFPA 70E look-up table results for different working distances & generate simple summary reports to communicate the results to personnel
- Alerts for PPE ATPV rating violations (maximum allowable PPE arc rating alerts)
- Find the safest mode of operation for maintenance work
- Automatically batch print arc flash labels based on highest incident energy from all operating modes

NFPA 2009 Standard

ETAP gives the option of defining your own user-defined categories or to use categories defined by NFPA 70E-2000, 2004 and now the new 2009 standard.

Single-Phase Arc Flash Calculations

In addition to 3-phase systems, ETAP 7.0 allows you to perform arc flash calculations for 1-phase panel / UPS systems.

Arc Flash Result Analyzer

The Arc Flash Result Analyzer is a time-saving tool that allows you to compare and analyze different reports coming from different projects, within the same directory, in a single display. You can compare the results of general information about the project or more specific information such as the results contained from buses, protective devices, or load terminals in an arc flash study.

Features

- Sort results from different studies by multiple criteria
- Find the worst-case incident energy results
- Quickly isolate & identify arc flash mis-coordination
- Find which protective devices failed to operate



- Filter out & analyze only the higher hazard category results
- Filter out all equipment with % Ia variation problems
- Locate slow responding protective devices
- Export customized arc flash results to Excel reports
- Analyze the results in Metric or English units
- Color code & filter results by category

Work Permits

According to NFPA 70E guidelines, permits are required when performing work on energized equipment. Work permits include shock hazard and arc flash analysis results. The work permit needs to be generated or individual bus arc flash results in addition to other pertinent information.

Data Sheets

The Data Sheet is an enhanced version of the arc flash analysis report. It gives detailed description of what selections were made in the Short Circuit study case and how the bus results were obtained. Data sheets can be customized to communicate arc flash study parameters.

Arc Flash Labels

ETAP has a wide variety of professional quality arc flash labels in multiple languages including English, Spanish, Portuguese, and now French. Automatically batch print arc flash labels based on highest incident energy from all operating modes.

Motor Contribution and Low Voltage equipment handling

ETAP makes it easier to specify considerations that should be applied to low voltage equipment like motors and transformers based on NFPA 70E 2009 & IEEE 1584.

Features

- Consider motor fault current decay during the arc flash calculation
- Automatically exclude small motor contributions entirely from the simulation
- Automatically identify and exclude transformers with relatively low voltage and kVA
- Assign a hazard category to these types of equipments automatically based on fault current ranges

Global Data Entry

Speed up data entry for your arc flash projects by globally applying arc flash analysis data based on equipment type and voltage rating.

Features

- Global definition of arc flash analysis data eliminates the need to specify this information in each bus
- Global definition of working distance, bus gaps, approach boundaries, and voltage-rated glove classes
- Specify Arc Flash Analysis Data based on IEEE 1584 2002 or user-defined values
- Globally select Shock Hazard Analysis Data based on NFPA 70E 2004, 2009 or user-defined settings
- Globally change the class settings given by ASTM D 120-02a Standard for voltage-rated protective gloves
- Updates can be made globally without having to modify each bus editor individually



3. ETAP Star

ETAP 7.0 includes an extensive list of enhancements for the ETAP Star module. Using these new user-oriented capabilities, the process of design and evaluation of protective device coordination is significantly faster and easier. Among them is the Star Sequence-of-Operation with new short circuit fault types: Line-to-Line, Line-to-Line-to-Ground in addition to 3-phase and Line-to-Ground.

Sequence of Operation

Star Sequence-of-Operation evaluates, verifies, and confirms the operation and selectivity of the protective devices for various types of faults for any location directly from the one-line diagram and via normalized TCC curve views. Sequence-of-Operation provides a system wide solution for an accurate and realistic operating time and state of protective devices, such as relay, fuse, circuit breaker, trip devices, contactor, etc. The operation time is calculated for each protective device based on its settings, time current characteristic, and interlocks for a specified fault location and type. ETAP 7.0 enhances this invaluable tool by including Line-to-Line and Line-to-Line-to-Ground Drag-and-Drop Faults in addition to 3-Phase and Line-to-Ground Faults.

Device Settings Report

Star Device Coordination Report Manager provides comprehensive and customizable device settings reports. The manager allows you to preview and print the protective device settings data, using Crystal Reports format or Microsoft Excel format.

Panel System Protective Device

ETAP 7.0 provides the capability to plot the time-current curves for the main disconnect circuit breaker and fuse as well as the branch circuit protective device curves.

Relay Current Summation

Relay element includes a new feature for summing flows through current transformers that can be utilized in arc flash evaluation and sequence-of-operation analysis. Similar to the differential relay, the summation function sums up the short circuit contribution vectors through the connected CTs according to the CT's polarity and the direction of current flow.

Features

- Partial Differential Relay Modeling
- Ring-Bus Protection
- Multiple Source Systems Protection

Relay Test Set Interface

In addition to ARTTS-6 relay hardware test set interface, ETAP Star now provides an interface to Megger® MPRT Protective Relay Test System via AVTS software.



4. Data Exchange

ETAP Data Exchange is used to import, export, and synchronize data between external data sources and ETAP. DataX provides many utilities including:

- Legacy data transformation into ETAP
- Interface with external architecture databases
- Customizable data mapping
- Intelligent error checking
- Automatic one-line diagram generation

DataX includes several new conversion programs that allow for conversion of third party electrical power system databases to ETAP. The conversion program will automatically generate a multi-layered graphical one-line diagram. A list of available conversion programs are available upon request.

SmartPlant Electrical Interface

The ETAP-SPEL Data Exchange Interface provides data synchronization between ETAP and Intergraph's SmartPlant Electrical (SPEL). This bidirectional interface allows joint users to utilize ETAP for design, analysis and automation, and then integrate that data into SPEL to increase electrical efficiency for the construction, operation, and maintenance for the life cycle of the plant.

- Import data from a SPEL published XML file
- Export date into a XML file for SPEL importing
- Import cable library data from a SPEL exported MS database
- Export cable library data to a MS database for SPEL importing
- Data mapping between SPEL equipments and ETAP element
- Synchronization of the ETAP cable library with the SPEL cable reference

The SPEL XML file contains the electrical data for equipment and connectivity information in the SPEL project. The ETAP data exchange interface uses information available in SPEL to add, modify, and delete elements. The interface not only auto creates one-line diagrams, it also facilitates multiple data transfers (synchronization) between ETAP and SPEL. As a result, data in ETAP and SPEL are kept consistent without going through the time-consuming manual process of recording additions and modifications in both systems.

The ETAP-SPEL cable library data synchronization is bridged by a Microsoft Access database. Users can import or export ETAP project cable library data into or from the Microsoft Access database using the ETAP Lib Utility. Through the SPEL Lib Utility, users can also export or import cable library data into or from the Microsoft Access database.

Open Format Excel DataX

Import from an Excel spreadsheet with any input data, layout, format, & field names

- Sync Motor
- Induction Motor
- Lumped Load
- Static Load
- 2-Winding Transformer



- Cable
- Bus

Intelligent equipment mapping

- Recognize the type of the equipment upfront
- Map equipments as new or existing

Customizable equipment mapping

- Change the default mapping for equipment already mapped
- Skip importing selective equipment in the user-interface

Customizable data mapping

- Change the equipment data mapping in the mapping table

Customizable logic for data dictionary

- Recognize input data based on the default logic provided in XML file
- Add customized logic to the default logic in the XML file for more import flexibility

Add customized captions and headers to the spreadsheet

5. Load Analyzer

The Load Analyzer module is designed as a generalized load list to report load schedules for power system components such as switchgear, MCC, transformers, cables, lines, panels, etc. Different reports provide informative data regarding all loads connected downstream to the equipment. Load Analyzer is an invaluable tool during the design / planning phase as well as analyzing existing electrical systems because running system studies like load flow analysis may not be possible due to incomplete one-line diagram or data.

Load Analyzer Reports

- Bus Feeder Loading
- Bus Loading Summary
- Equipment Loading
- Equipment Load List
- Loading Schedule
- Cable Schedule
- Transformer Schedule

6. Enhanced Elements

Low Voltage Solid State Trip Device

- Enhanced modeling capabilities

Battery

- Rp value can be given for each size



7. Enhanced Modules

Short Circuit

ETAP Short-Circuit module has enhanced duty calculations for generator circuit breakers per the latest version of IEEE Std C37.013, “IEEE Standard for AC High-Voltage Generator Circuit Breakers Rated on a Symmetrical Current Basis”. The generators are modeled by the sub-transient dynamic model to represent AC and DC decay of short-circuit contributions from the generator. It calculates both system-source and generator-source short-circuit currents and considers no-load, lagging PF load, and leading-PF load for pre-fault conditions.

ETAP provides several options for multiplication factor (MF) for high-voltage circuit breaker and bus momentary duty calculations. The options include MF calculated based on system X/R, fixed values at 1.6/2.6, or use of 1.6/2.6 as minimum values. These options allow the user to obtain accurate results as well as to ensure conservativeness in short-circuit calculations.

Features

- Generator sub-transient model to represent AC and DC decays
- Generator-source and system-source short-circuit currents with no-load, leading PF, and Lagging PF
- Symmetrical, asymmetrical, and peak kA at 1/2 cycle
- Symmetrical, asymmetrical, peak, and DC kA as well as degree of asymmetry at generator CB contact parting time

Transient Stability

The latest edition of ETAP provides the following new capabilities to transient stability, making it the most powerful stability program in the industry hands-down.

Features

- State-of-the art Governor-Turbine models used in the majority of large industrial power systems
- Isochronous / Droop switching capability for Gas Governor-Turbine with GE Mark IV, V & VI model (GGOV3)
- Solar Gas Governor-Turbine with DLN combustion system model (SGOV1)
- Westinghouse Gas Governor-Turbine with jump rate limiter model (WGOV1)
- Ability to simulate the new Governor-Turbine dynamics including manufacturer unpublished details
- Governor-Turbine models are fully verified and validated by field measurements / benchmark tests
- Higher order integration solution method for synchronous machine swing equation
- Synchronous machine typical data

Harmonics

The Newton-Raphson method for initial load flow provides an improved convergence for larger systems with small impedances.



8. System Requirements

Operating System (32-bit or 64-bit)

- Microsoft® Windows Vista (Home Premium, Business, Enterprise)
- Microsoft® Windows® XP (Service Pack 3) Professional or Home Edition
- Microsoft® Server 2003 (Service Pack 2), Microsoft Server 2003 R2 (Service Pack 2)
- Microsoft® Server 2008

Other Software Requirements

- Internet Explorer 5.01 or higher (or minimum version level as specified by the Operating System in use)
- Microsoft® .NET Framework v1.1, Service pack 1
- Microsoft® .NET Framework v2.0, Service pack 1

PC Configuration Requirements

- USB port (if stand-alone licensing required)
- Ethernet port w/network access (if network licensing required)
- DVD Drive
- 5 to 80 GB hard disk space (based on project size, number of buses)
- 19" monitors recommended (dual monitors highly recommended)
- Minimum display resolution -1024x768

Recommended Hardware Requirements

100 Bus Projects

- Intel Dual/Quad core – 2.0 GHz (or equivalent)
- 2 GB of RAM

500 Bus Projects

- Intel Dual/Quad core – 2.0 GHz (or equivalent)
- 4 GB of RAM

1,000 Bus Projects

- Intel Dual/Quad core – 3.0 GHz with Hyper-Threading with high speed bus (or equivalent)
- 8 GB RAM (high-speed)
- 64-Bit Operating System

10,000 Bus Projects and Higher

- Intel Dual/Quad core – 3.0 GHz with Hyper-Threading with high speed bus (or equivalent)
- 12 GB RAM (high-speed)
- 64-Bit Operating System



Library Additions

The following protective device manufacturers and models are added to the library.

	MFR	Model
HVCB	ABB	121PM20, 121PM40, 121PM50, 121PM63, 145PM20, 145PM40, 145PM50, 145PM63, 169PM20, 169PM40
	Toshiba	VK-10M25A2, VK-10M40A, VK-10M40AH, VK-10M50, VK-10P25A2, VK-10P40A, VK-10P40AH, VK-10P50, VK-10Q40, VK-10Q40H, VK-10Q50, VK-20J13, VK-6M32A, VK-6M40A, VK-6M50, VK-6P32A, VK-6P40A, VK-6P50, VK-6Q50, VK-8M40A, VK-8P40A, VK-8Q40, VY-20M25A, VY-20P25A, VY-30M25A, VY-30P25A

RELAY	MFR	Model
	ABB	50B, COQ, KAB, IRC, IRD, IRP, SSC-T, REX 521,
	Areva	CAG17, CAG37, CTU12, CTU22, CTU32, CTU62
	BBC	ISM2, ISM 21
	Cooper	iDP-210
	Cutler-Hammer	IQ-1000 II, FP-4000, FP-5000
	Eaton	MP4000
	Federal Pioneer	GFR
	GE Multilin	MIF II, MIF-P, IAC-99AY, T35, MM300, MIF-P, MIF-N, B90
	Merlin Gerin	SEPAM 20, SEPAM 40
	Mitsubishi	CMP2 - A02D2, COC4-A02D1
	P&B Engineering	Advanced Feedervision II, Advanced Motorvision II, Feedervision II, Microfeeder Plus, Microvision Plus, Motorvision II, MPC 2000+, MPC 2000D, MPR 10, MPR 2500, MPR 3E5, MPR 3E5 (Vision 100), PBSJ 120, PBSJ 140C (SPCJ 4D29), PBSJ 3E5 N11
	Reyrolle	Rho 3
	S&C Electric Co.	ZSD
	Schweitzer	Rho 3, 387A, 751A, 710, 487B, 487E, 9995A, 787, MGFR-1-ZB, MGFR-2-ZB, MGFR-20-ZB, MGFR-200-ZB, MGFR-1200-ZB, MGFR-SE-ZB, 587Z
	Siemens	3UF7
	Square D	SEPAM SERIES 40, SEPAM SERIES 80
	Startco Engineering Ltd.	MPU-16A, SE-701, MPS, MPU-32, FPU-16, FPU-32, SE-134C
	Thytronic	DIG 5200
	TMT&D	CAC1-A01D2, COC1-A01D1
	Vamp	Vamp 230, Vamp, 245, VAMP 255, VAMP 257
	Westinghouse	IT, ITH, ITH-T



Fuse	Bussman	LPS-RK_SPI (12/00)
	GEC	CC, CCP, CF, CFP, CIA, CIS, CLM, CM, CMF
	Gould Shawmut	A25Z-2, CRN, CRS, NRN, NRS
	Hi-Tech Fuses Inc	Trans-Guard OS, Trans-Guard OS Shorty
	Littelfuse	CCMR, KLLU
	Reproel	FH-15, FH-17, FH-18, FH-25, FH-27, FH-28, FH-35, FH-37, FH-38, FH-45, FH-47, FH-48, FH-55, FH-57, FH-S40, FH-S50

	MFR	Model
LVCB	Cutler-Hammer	MH, MS
TM	Cutler-Hammer	CC, CCH, MH, MS,
MCP	General Electric	TEC (02/04), TFC (03/97), TJC (03/97), TKC (03/97),
LVSST	Square D	ET1.0 (MG), ET1.0 (MJ), ET1.0 (PG), ET1.0 (PK), ET1.0 (PL), ET1.0 (RG), ET1.0 (RJ), ET1.0 (RK), ET1.0 (RL)
	Terasaki	AGR-L (LT Curve), AGR-R (LT Curve)

	Source	Conductor Type
Transmission Line	Southwire	AAAC, AAC, AAC/W, AACSR, ACAR, ACSR/COMP, ACSR/TW, ACSS, ACSS/AW, ACSS/TW, CU, CW, CWC, VR
	Southwire/M. Layer	ACSR, ACSR/AW
	Southwire/S. Layer	ACSR, ACSR/AW
	Southwire/SL. HST	ACSR, ACSR/AW

	MFR	Model
Electronic Reclosers	Cooper	VFI (5kV), VFI (15kV), VFI (25kV), VFI (35kV)

	MFR	Model
Overload Heater	General Electric	CR124



ETAP 6.0.0

March 2008

The OTI Development Team is pleased to provide you with the enclosed ETAP 6.0.0 release. ETAP 6.0.0 is a complete program and does not require any previous ETAP installation.

ETAP 6.0.0 is a major release that delivers new capabilities to significantly enhance your power system analysis experience while making the process faster and easier. This version is enhanced with easy to use features that allow you to easily create and organize a one-line diagram with one click operations. The new enhancements and analysis modules are still developed with mathematical precision using our Quality Assured Verification and Validation Procedure.

The first time you run ETAP 6.0.0, you will need to enter the 36-Digit CD Activation Code as provided on the ETAP 6.0.0 installation CD.

For more information on this new release, please take a few moments to review the information below.

New Features

- *Graphical Undo & Redo*
- *Graphical Alignment Tools*
- *Group Rotation*
- *Element Mirroring & Polarity*
- *Coloring Based on Voltage Level*
- *Voltage Propagation (Single-Phase)*
- *User-Defined Symbol Text*

New Analysis Modules

- *Cable Ampacity & Sizing - BS 7671*
- *Single Phase Duty Calculation*
- *Panel Systems Duty Calculation*

New Elements

- *Reclosers*
- *Differential Relays*
- *In-Line Overload Relay*
- *Motor-Generator Set*

Enhanced Modules

- *Load Flow*
- *Arc Flash Analysis*
- *Transient Stability*
- *Star TCC*
- *Star Sequence of Operation*
- *Motor Starting & Acceleration*
- *Ground Grid System*
- *GIS Map*
- *Data Exchange*

New Libraries

- *Reclosers*
- *Differential Relays*
- *Maintenance Mode Setting*

New Tools

- *Study Result Comparator*



1. One Line Diagram

Undo/Redo

ETAP One-Line Diagram now remembers unlimited graphical actions with the help of graphical undo/redo feature also widely known as the Oops command. You can now backtrack single or multiple steps to correct mistakes or reverse the effect of the undo command by using redo.

Features

- Unlimited Undo / Redo Actions within Individual Presentations
- Undo/Redo Actions within composite networks
- Undo/Redo show/hide protective devices
- Undo/Redo movement of any device
- Undo/Redo moving, adding or deleting a connection
- Standard Keyboard Shortcuts (Undo - CTRL+Z, Redo - CTRL+Y)

Graphical Alignment Tools

ETAP One-Line Diagram just got a lot more intelligent with the help of graphical alignment tools. Select a portion of the one-line diagram and use any of the 10 available alignment features to automatically arrange elements.

Features

- Straight & Space Alignment
- Horizontal Alignment (Middle, Top, Bottom)
- Vertical Alignment (Left, Center, Right)
- Distribute Spacing (Horizontal, Vertical)

Coloring Based on Voltage Level

The Theme Manager allows you to create and recall templates for the graphical display of elements, connectors, annotations, results, alerts and background colors on the one-line diagram. The ETAP one-line diagram can now be automatically color coded based on nominal system voltages. Up to 20 user-defined voltage levels and colors can be used to turn any one-line diagram into an intuitive and easy to understand system model.

Features

- Up to 20 user-defined voltage levels and colors
- Instantly create or switch between multiple color schemes using theme templates
- Set different themes for individual one-line diagrams



Relay & Current Transformer Mirroring

- Mirror Current Transformer and Connected Relays with One Click
- Improve one-line diagram layout and make your one-line diagrams more professional.
- Simply select a current transformer or relay and use right-click context menu to mirror the component

Relay & Current Transformer Polarity

- Reverse Current Transformer Polarity based on Directional Settings
- Set correct polarity for current sensing for differential, directional and reverse power relays
- Simply select a current transformer and use right-click

User Defined Symbol Text

- User-defined symbol text, size and font style
- Mark protective devices with device number in case of multi-function relays

Group Rotation

- Rotate selected elements or single elements by 90, -90 180 degrees.

Voltage Propagation

In addition to the existing voltage propagation on three phase networks, the voltage propagation is now capable of detecting single-phase connections and propagating voltage through single-phase two wire and three wire systems as well as panel systems.



2. Enhanced Modules

Load Flow

The Load Flow Result Analyzer is a time saving tool that allows you to compare and analyze different reports coming from different projects, within the same directory, in a single display. You can compare the results of general information about the project or more specific information such as the results contained from buses, branches, loads or sources in a load flow study.

Features

- Compare and View Multiple Load Flow Results in One View
- Analyze and Compare Reports from Multiple Projects
- Create a base line report and quickly identify deviations for all cases
- View Multiple Bus, Branch, Loads and Source Results at a glance
- Advanced Alert and Warning feature identifies and highlights components that are overstressed and need your attention
- Quickly find components on the one-line diagram from the analyzer view
- Export summary view into MS Excel for maximum data flexibility

Short Circuit

The highly capable Short Circuit Analysis is more diverse and, in addition to ANSI/IEEE and IEC methods for 3-Phase short circuit current calculation, can now perform 1-Phase device duty short circuit study. ANSI and IEC 60909 Standards are available for calculating short circuit current for a main panel, sub-panel, UPS and phase adapter. Single phase device duty calculation compares the calculated fault current for evaluation of protective devices and generates critical and marginal alerts based on user-defined limits. Loads and motors, even if they have protective devices, monitoring devices and a cable, do not need their own buses/nodes. And yes, load terminal voltages and voltage drops are calculated and displayed on the one-line diagrams. ETAP 6.0 takes this functionality to the next level by not only calculating but also displaying and reporting the short circuit current at all load terminals that have equipment cables. The benefits include is faster calculation time, de-cluttered one-line diagram and more concise reporting.

Features

- Include all panel subsystems in device duty calculations
- Include all UPS systems in device duty calculations
- Include all Single phase systems in device duty calculations
- Calculate the load terminal fault current for Motor, MOV, Static Load and Capacitor
- IEC compound excitation modeling for I_{kmin} based on IEC 60909-0 2000.
- Enhanced display options to allow display of 3-Phase and 1-Phase SC results from the same study
- Enhanced modeling of synchronous machines impedance values like $R2/X2$ and $R0/X0$
- Positive tolerance adjustment for calculating minimum short-circuit currents
- Enhanced detection of 1-Phase connections for short-circuit load terminal faults
- Calculate device short-circuit duty for ANSI/IEC reclosers



Arc Flash

ETAP Arc Flash Analysis estimates the arc flash incident energy under a bolted 3-phase short circuit fault and determines the flash protective boundary to live parts for shock protection. Design safer power systems by insuring compliance with OSHA 29 CFR 1910.132(d) 1990, NFPA 70E-2004, and IEEE 1584-2002 Standards. Arc Flash now provides the flexibility to calculate arc flash results at load terminals that are fed via equipment cables.

Features

- Motor / Load Terminal Arc Fault Calculation
- Maintenance Mode Switch for Low Voltage Solid State Trip device
- Relay actions (79, 87, 49, 27, 59, 67) in arc fault calculation
- Enhanced search capabilities for source protective devices
- New arc flash label templates (English, Spanish & Portuguese) with user-defined text fields
- Enhanced user-defined fixed fault clearing time

ETAP STAR

ETAP 6.0 includes an extensive list of enhancements for the ETAP Star module. Using these new user-oriented capabilities, the process of design and evaluation of protective device coordination is significantly faster and easier. Among them is the Star Sequence-of-Operation with enhanced handling of protective devices such as differential relay (87), directional relay (67) and voltage relay (27).

Generator Decrement Curve

ETAP 6.0 now allows you to plot a generator decrement curve on a Star View and display both, the symmetrical and asymmetrical decrement curve based on generator no-load or full-load conditions. Excitation system field forcing capability used to speed up the response of the generator is also considered when plotting the generator decrement curve.

Motor Starting Curve Based on Multiple Starting Voltage

A motor starting curve can be plotted on a Star View for the purpose of determining overload settings for motor protection devices. Constant Terminal Voltage can be used to plot the motor starting curve based on a constant voltage at the motor terminal. ETAP 6.0 now allows you to create multiple approximate motor starting curves. A constant 100% terminal voltage is given with the option of specifying two more %terminal voltage values.

Stator Damage Curve

The motor curves have been enhanced by including stator damage curve or running overload curve into ETAP Star. Stator curves can be plotted based on multiples of machine full load amps or actual amp values.

Reference kV

STAR will plot the TCC curve based on the calculated Base kV or User-Defined kV in reference to the STAR view plot kV.



Transient Stability

The latest edition of ETAP provides the following new capabilities to transient stability making it the most powerful stability program in the industry hands-down:

Features

- Initial Load Flow using Newton Raphson Method in addition to Accelerated Gauss Siedel
- Faster Calculation Time by providing option to skip tabulated plots
- New transient event - Line to Ground Fault
- New GE Turbine-Governor Model (GGOV3)
- New Exciter IEEE ST4B
- Auto Sync-Check Action
- Enhanced Synchronous Machine Saturation Factor
- Enhanced Synchronous Machine Salient-Pole Model

Output Report Comparator

ETAP provides a time-saving capability to automatically run multiple scenarios with different project files and verify their study results against benchmark reports. Once set up, you can compare hundreds of study reports together with one action. This is also a great tool for the internal verification and validation of a new version of ETAP after initial installation.

Cable Sizing and Ampacity

ETAP 6.0 is the only program to offer cable sizing and ampacity calculation based on:

- IEEE 399, The Brown Book
- ICEA P-54-440
- NEC
- British Standard 7671

Sizing based on:

- Vd
- Size based on Motor Terminal Voltage at Setting

Installation Type

- Trenches
- Embedded Direct
- Brackets
- Cleats
- Ladder
- Open and Clipped Direct
- Building Voids
- Trunking



Motor Starting

- Faster Calculation Time by providing option to skip tabulated plots

Ground Grid Systems

- Added sorting capability for conductors

Data Exchange

- Enhanced user interface for data synchronization
- Added Sequence (.seq) and Dynamic (.dyr) data with Raw data import



3. New and Enhanced Elements

Recloser

- Hydraulic
- Electronic with Static Controller
- Electronic with Microprocessor Controller
- Device Coordination (Star) - Star SQOP
- ANSI/IEC Short-Circuit Duty Evaluation
- Overload alerts in Load Flow Analysis
- Comprehensive library of old and new reclosers / controllers
- Detailed modeling of reclosing device

Differential Relay

- Partial-Bus, Total Bus, Transformer, Line & Cable
- Percentage and High Impedance Types
- Device Coordination (Star) - Star SQOP
- Considered in Arc Flash Analysis
- Library of differential relays
- *Please note that checker functions for multifunction differential relays may show the relay as unchecked if you remove other functions like overload or overcurrent.*

In-Line Overload Relay

- Library of in-line overload relays
- Automatic voltage

Synchronous Motor Capabilities

- Enhanced Model page

Synchronous Generator Capabilities

- Enhanced Imp/Model page



Library Additions

The following protective device manufacturers and models are added to the library.

	MFR	Model
Electronic Reclosers	ABB	OVR-1 Series Rs14x-RS28x, OVR-3 Series R111x-R378x, VR-3S Series V115x-V378x
	Cooper	NOVA1-15 400-800A, NOVA1-27 400-800A, NOVA15, NOVA27, NOVA38, NOVA-TS-15 400-800A, NOVA-TS-27 400-800A, PWE, PWVE, RXE, VSA12, VSA12B, VSA16, VSA20, VSA20A, VSO12, VSO16, VWE, VWVE27, VWVE38X, WE, WVE27, VWVE38X, WE, WVE27, WVE38X, VXE15, VXE27
	FKI Switchgear	GVR15, GVR27, GVR38
	G&W Electric	Viper-G 15.5kV – 38kV, Viper-S 15.5kV-38kV, Viper-ST 15.5kV-38kV
	Joslyn	TriMod 100 (115-xxx-630), TriMod 100 (115-xxx-800), TriMod 100 (127-xxx-630), TriMod 100 (127-xxx-800), TriMod 300 (315-xxx-630), TriMod 300 (315-xxx-800), TriMod 300 (327-xxx-630), TriMod 300 (327-xxx-800), TriMod 300R (315R-xxx-630), TriMod 300R (315R-xxx-800), TriMod 300R (327R-xxx-630), TriMod 300R (327R-xxx-800), TriMod 600R (615R-xxx-630), TriMod 600R (615R-xxx-800), TriMod 600R (627R-xxx-630), TriMod 600R (627R-xxx-800)
	S&C Electric Company	TripSaver (15.5kV 100A), TripSaver (15.5kV 50A), TripSaver (27kV 100A), TripSaver (27kV 50A)

Hydraulic Reclosers	Cooper	4E Series 50A-280A Coils, 6H Series 5A-100A Coils, V6H Series 5A-200A Coils, D Series 100A-560A Coil 400X-560X Coil, DV Series 100A-560A Coil 400X-560X Coil, E Series 5A -100A Coil, H 5-50A Coil, L Series 50A-200A Coil, V4E, V4L, VW Series 50A-560A Coil 280X-560X Coil, VWV27 Series 50A-560A Coil 280X-560X Coil, VWV38X Series 50A-560A Coil 280X-560X Coil, W Series 50A-560A Coil 280X-560X Coil, WV27 Series 50A-560A Coil 280X-560X Coil, WV38X 50A-560A Coil 280X-560X Coil, 4H Series 5A-100A Coil, V4H Series 5A-140A
----------------------------	--------	--



	MFR	Model
Microprocessor	ABB	ICD
	Cooper	Form 4C, Form 5, Form 5 Triple-Single, Form 6, Form 6 Triple-Single, FXA, FXA/FXB, NOVA1 Control, VXE Control
	FKI Switchgear	Panacea (SEL-351P)
	Joslyn	351J, Faultmaster 2500, PowerMAX 100
	Nu-Lec	ADVC
	Schweitzer	351R, 651R
Static	Cooper	Form 3A, Form 3A (RE, RVE, RXE), Form 3A (Type VSA), Form 3A (Type VSO), Form 3A (W-group)
	S&C Electric Company	TripSaver (100K), TripSaver (50K)

RELAY	ABB	REA 101, REM543, SC, SC-1, REF 545, REL 561
	Allen Bradley	SMP1, SMP3, 825-P
	Areva	P-132
	GE Multilin	G650, C60, F650, 735/737
	P&B Engineering	MREF
	Schweitzer	710 (R100), 701 (R106-R113)
	Square D	Sepam Series 20, GC-200

Fuse	Combined Technologies	X-Limiter (E rated)
	Cooper	GMA
	Cutler Hammer	CLS, CLS(07/03)
	ETI	VV
	Gould Shawmut	A051B
	Kearney	Type Q
	Siemens	3NA3 1..-6, 3NA3 2..-6, 3NA3 3..-7, 3NA3 8..-6



	MFR	Model
LVCB	Cutler-Hammer	MDS-Cxx
	Federal Pioneer	CE-B, CE-E, CE-E4, CE-H, CE-N, CJM-E, CJM-H, CJM-N, CK-E, CK-H, CK-N, CMH, FKD, FKG, HEW, HEZ, TH1, TH4, TH8, CJL-E, CJL-N, CJL-H
	Merlin Gerin	C60N Series, C60H, C60L
	Square-D	QB, QD, QG, QJ, QE-VH
	Nikko	SK202, SK203, SK204
	Siemens	HEG, NEG
TM	Federal Pioneer	CMH, CJM, CE-B, CE-E, CE-E4, CE-H, CE-N, FK-D, FK-G, HEW, HEZ, TH1, TH4, TH8, CJL-E, CJL-N, CJL-H
	Merlin Gerin	C60N C-Curve, C60N/H D-Curve, C60N/H/L C-Curve, C60N/H/L B-Curve
	Nikko	SK225
	Square-D	QB (50 Hz) (60Hz), QD (50 Hz) (60Hz), QG (50 Hz) (60Hz), QJ (50 Hz) (60Hz)
	Siemens	HEG, NEG
LVSST	Cutler-Hammer	MDS-Cxx
	Federal Pioneer	LES3600LS/LSG, LES3600LSI/LSIG, STR45SP, STR55UP, KES3125LS/LSG, KES3250LS/LSG, KES3400LS/LSG, KES3125LSI/LSIG, KES3250LSI/LSIG, KES3400LSI/LSIG
	Square D	GC-100



ETAP 5.5.6

March 2007

The OTI Development Team is pleased to provide you with the enclosed ETAP 5.5.6 release. ETAP 5.5.6 is a complete program and does not require any previous ETAP installation.

This point release is the latest in the ETAP 5.5 series and includes several enhancements and modifications from the earlier 5.5.5 release. We recommend that you utilize this latest release in order to take advantage of the new features and capabilities. Note that network users must also update their ETAP License Manager. The updated License Manager is compatible with earlier releases.

ETAP 5.5.6 will utilize the same 36-Digit Key Code as provided with the ETAP 5.5.5 release.

For more information on this new release, please take a few moments to review the information below.

1. Library Additions

The following protective device manufacturers and models are added to the library.

	MFR	Model
RELAY	Startco Engineering	SE-320, 325
	ABB	REJ 525, REF 610, REM 610
	GE Multilin	MM3, TMC14B, IAC-60T, IAC-80T, IAC-90T
	VA TECH	Argus 1, 2, 4, 6

TM	ABB	BQD, CQD, S1 125 Series
-----------	-----	-------------------------

HVCB	Siemens	GMI Series
-------------	---------	------------

Fuse	Siba	HHD Series, 7.2 to 38.5 kV
	Cooper	ELF-LR Series, 13.2 to 23 kV
	General Electric	55A21 Series, 2.54 to 5.08 kV
	General Electric	218A4293 Series, 2.54 to 5.08 kV
	Littelfuse	KLKD, 0.6 kV



2. Protective Device Library Information Exporting Tool

An ETAP tool is added to this version to extract library information for all protective devices in an ETAP project. The extracted information is exported to a Microsoft Excel file which is placed in the ETAP project directory. The extracted information includes device ID, Type, Manufacturer, Model, etc. This handy tool can be used to easily determine protective devices that utilize specific device libraries.

Once you install ETAP 5.5.6, a tool named “PD Library Export” will automatically be added to the ETAP Tools menu. To use this tool, open ETAP Tools menu and click on the PD Library Export tool. A Microsoft Excel file will be generated in the ETAP project directory with a file name “PDLibExport-XXX.xls”, where XXX will be replaced by the ETAP project file name.

You can change the Excel filename from the ETAPS.INI file. To change the filename, open the ETAPS.INI file from your application directory (by default installation C:\ETAP 556) and locate the statement for the tool in the [AppVariables] section, which should be similar to the following. Change the blue section “PDLibExport” to the name you prefer. Note that if the ETAPS.INI file is not in the application directory then use the ETAPS.INI located in your windows directory.

```
Tool1=PD Lib Export|<etaps.exe folder>\FIGDBExtractConsoleApp.exe|%p.MDB|%d
  \PDLibExport-%P.XLS|OpenXLS
```

3. Arc Flash

In ETAP 5.5.5, under a set of very special conditions (Low Voltage Solid State Trip LVSST with Short-Time I^2t delay band set to “IN” while the library is set to zero), the calculated fault clearing time is different from the actual clearing time if the Source Protective Device is one of the libraries listed below. ETAP 5.5.6 has been enhanced in this version to handle these special conditions.

Siemens	3WN6 D/E/F/H/J/K/N/P, ETU 45B/55B/745/745/76B
Merlin Gerin	MICROLOGIC 5.0/ 6.0, STR 35/38/45/53/55/58
Moeller	IZM-U
Square-D	MICROLOGIC 5.0/ 6.0, RMS 510/610/810
Westinghouse/Cutler-Hammer	Digitrip 310+, RMS 500 Series 510/520
General Electric	Entelliguard

ETAP 5.5.5



December 20, 2006

The OTI Development Team is pleased to provide you with the enclosed ETAP 5.5.5 release. ETAP 5.5.5 is a complete program and does not require any previous ETAP installation.

This point release is the latest in the ETAP 5.5 series and includes several enhancements and modifications from the earlier 5.5.0 release. We recommend that you utilize this latest release in order to take advantage of the new features and capabilities. Note that network users must also update their ETAP License Manager. The updated License Manager is compatible with earlier releases.

ETAP 5.5.5 will utilize the same 36-Digit Key Code as provided with the ETAP 5.5.0 release.

ETAP 5.5.5 allows you to explore the ETAP Real-Time capabilities including Power System Monitoring & Simulation (PSMS), Energy Management System (EMS), and Intelligent Load Shedding (ILS). A sample system is provided along with the ETAP Real-Time installation which allows you to take ETAP online and experience the power of ETAP Real-Time enterprise. For more information, please contact sales@etap.com or visit our web site at etap.com.

For more information on this new release, please take a few moments to review the information below.

1. Library

- Cable library
Added Olex Cable library
- Fuse library
Added the following models:

MFR	Model
Bussmann	OEF, OHF, OLG, OEG, OHG, NH Series
Cooper	Bay-O-Net (High Ampere), ELSP, X-Limiter
Cutler-Hammer	CLS (07/03), CLE (0703)
Little Fuse	FLSR (01/03)
Siemens	3NA Series
Gould Shawmut (Ferraz)	A50P

- Low Voltage Circuit-Breaker library
Added the following models:

MFR	Model
Square-D	HD, HG, HJ, HL, JD, JG, JJ, JL, GJL
Cutler-Hammer	PA, T4 and T5 Series, HFA, HMDL-DC, ELFD, ELFDC, ELHFD, ELHJD, ELHKD, ELJD, ELJDC, ELKD, ELKDC
ABB	S500 Series
Westinghouse	PA, T4 and T5 Series, HFA

- Low Voltage Solid State Trip library
Added the following model:

MFR	Model
ABB	SACE PR221, SACE PR121, SACE PR122, SACE PR123

- Thermal Magnetic Circuit-Breaker library
Added the following models:

MFR	Model
ABB	T4, T5 Series
Federal Pacific	HEF, NE, NEF Series
Cutler-Hammer	HMDL-DC, NH, NS, HFA, PA
Square-D	Powerpact H and J frame Series, GJL Series

- Relay library
Added the following models:

MFR	Model
ABB	REF 543, REF 541, SPAJ 110C, SPAJ 111C, SPAJ 115C, SPAJ 135C, SPAJ 141C, SPAJ 142C, SPAJ 144C, RAMDE, REM 545, SPAD 346C, SPAJ 1B1 J3
Schweitzer	311L
AREVA	P441
VAMP	VAMP 130, VAMP 140, VAMP 265
Beckwith Electric	M-3425
Siemens	7UM62
GE Multilin	G30
Orion Italia	IPR-A, SMPR
Startco Engineering	SE 105, SE 135

2. Localization

- Enhanced the program to handle period (.) or comma (,) decimal separators for float numbers.

3. GIS

- Upgraded ETAP GIS Map to interface with ArcGIS Version 9.1
- Enhanced ETAP GIS interface to work with ArcGIS run time engine

4. Short-Circuit

- For ANSI Device Duty of generator circuit-breaker, an automatic search is added to determine a single path between a generator and the generator circuit-breaker. For a generator and the associated circuit-breaker with a single path, the circuit-breaker duty is calculated by the system-only contribution or generator-only contribution.
- Added a new preference option to allow the user to decide if machine FLA to be included in duty calculations when the option of “Based on Maximum Through Fault Current” is selected for machine protective device duty.

5. DC Motor, DC Static Load, UPS, and Inverted Editors

The following options are added to the Duty cycle page for DC motor, DC static load, UPS and inverter.

Based on Amp / %Loading

This option specifies how the duty cycle is entered. When the Amp option is selected, the duty cycle is specified as amperes and the %Load will be calculated. When the %Load option is selected, the duty cycle is specified as percentage of FLA and the ampere values will be calculated

6. ETAP License Manager

The ETAP License Manager (LM) is updated for ETAP 5.5.5 release. This License Manager is compatible with earlier versions of ETAP.

The ETAP LM service may not start automatically after rebooting the ETAP LM server if virtual machine software exists on the same machine. If virtual machine software is present on LM server machine, it is recommended to verify that the 'ETAP Lic Mgr' service is running or start the service manually under System Services.



ETAP 5.5.0

June 19, 2006

Graphical Animation of System Response for Protective Device Operation Control System Logic Sequence Dynamic Behavior Operation

ETAP 5.5.0 is a major release that delivers new capabilities to significantly enhance your power system analysis experience while making the process faster and easier. Contributing to this objective includes the addition of new features to graphically animate the system response for Protective Device Operation, Control System Logic Sequence, and Dynamic Response Operation with more flexible configuration options and greater display.

Enhancing Your Power System in English, Chinese, and Japanese

New Features

- . Configuration Manager
- . ETAP Preferences
- . License Administrator
- . Theme Manager
- . Wind Turbine Generator

New Elements

- . Doubly-Fed Induction Generator
- . Tag-Link

New Capabilities

- . Cable Sizing Based on Short-Circuit
- . Configuration Checker
- . Get-Set Property Defaults
- . Output Report Navigation
- . MOV Voltage Limit
- . Sag & Tension for Unequal Towers
- . Text Box Default

Enhanced Modules

- . Advanced Relay Testing & Transient Simulator
- . Arc Flash Analysis
- . Battery Discharge & Sizing
- . Control System Diagram
- . Data Exchange
- . Energy Management System
- . GIS Map
- . Ground Grid Systems
- . Harmonic Analysis
- . Intelligent Load Shedding
- . Optimal Capacitor Placement
- . Panel Systems
- . Power System Monitoring & Simulation
- . Protective Device & Selectivity Coordination
- . Short-Circuit Analysis
- . Transient Stability Analysis

Wind Turbine Generator

The Wind Turbine Generator (WTG) module allows you to design and analyze wind farms via a highly flexible graphic interface optimized for steady-state and dynamic simulation. The WTG module is fully integrated with all ETAP calculation modules such as Load Flow, Short-Circuit, Transient Stability, Optimal Capacitor Placement, Harmonic Analysis, Protective Device Coordination, and ETAP Real-Time. User-defined actions may be added to simulate disturbances like wind variation, UGS electrical faults, and relay operations. It also predicts the dynamic response of each individual wind turbine generator. Analysis results may be utilized to evaluate alternative turbine placement, tuning of control parameters, selection and placement of protective devices, and sizing associated equipment.

The ETAP WTG module comes to market with proven utility. It is currently being used for real-time monitoring of power exchange between wind turbines and the power grid at one of the largest wind farms in the United States.

Features

- Ability to model unlimited wind turbine generators individually, or in groups
- Detailed modeling of turbine dynamics including aerodynamics & power coefficients
- Model doubly-fed induction generators with pitch & converter controller characteristics
- Simulate transient wind conditions with ramp, gust, & noise disturbances & calculate dynamic impact on wind machines
- Create multiple wind categories for predictive “what if” studies & scenarios
- Perform transient stability analysis with individual or zone-based disturbances
- Run one instance or continuous steady-state calculations in analysis mode

Advanced Relay Testing & Transient Simulator

ARTTS is a powerful combination of relay test-set hardware and protective device evaluation software that is seamlessly integrated to provide a complete relay testing and simulation package. With ARTTS Interface, you can simulate the actual relay response under steady-state and transient fault currents and compare the captured relay response with that of the manufacturer’s published curve. Observe and analyze deviations from nominal values and relay mis-operations. The graphical interface makes setup easy and all historical tests can be retrieved for plotting and comparison.

New Capabilities

- Test relays & import the test results into ETAP Star
- Test, simulate, & calibrate overcurrent, differential, & distance relays
- Fully integrated interface with ETAP Star & Short-Circuit modules
- Compare actual steady-state & transient responses of relays with published manufacturer specifications
- Playback transient waveforms for evaluation
- Archive relay test data for historical reference & retrieval
- Customizable test reports

ETAP 5.5 includes an extensive list of enhancements for the ETAP Star module. Using these new user-oriented capabilities, the process of design and evaluation of protective device coordination is significantly faster and easier. Among them is the Star Sequence-of-Operation with enhanced graphical animation of the operation of protective devices on the one-line diagram.

Graphical Animation of Protective Device Operation

New Features

- Virtual animation of sequence-of-operation playback on the one-line diagram
- Normalized TCC plots with shifted curves based on fault contributions
- User-definable curves & fault arrows
- Batch print TCC plots & diagrams for various paper sizes
- Automated color sequencing of TCC curves
- Enhanced print options & functionality
- Flexible user-definable display & plot options
- Star library Merge Manager
- Intelligent alert view for troubleshooting
- Enhanced relay library interface
- Acceleration curve for overload relays
- Transformer inrush curve
- Graphical TCC curve tracker with cross lines
- Expanded verified & validated device library
- New Relay Test-Set Interface for evaluating steady-state & transient relay response

Power System Monitoring & Simulation

The ETAP PSMS upgrade builds on its already solid capabilities in system management and simulation by providing these useful new features:

- OPC alarms & remote notification of events
- Place tag-link elements on one-line diagrams to display any digital & analog data
- Real-time data plotting & trending
- Create customizable reports for energy & power demands

Tag-Link Element

The new Tag-Link element brings measurements from metering systems, PLC, and SCADA into ETAP using a graphic element in the one-line diagram.

- Monitor electrical & non-electrical measurements
- User-definable alerts for both analog & digital measurements
- Specify alert sounds & colors for alarms & disturbance triggers

Energy Management System

EMS is a robust, flexible, and powerful system for data control and automation of industrial, commercial, distribution, and transmission systems. This intelligent energy management system is designed to reduce energy consumption, improve the utilization of the electrical system, increase electrical reliability, and predict electrical system performance, as well as optimize energy usage and reducing its cost. One of the significant functionalities included in EMS is a state-of-the-art load management application that provides intelligent load flow solutions to minimize operating costs and maximize system performance.

New Features

- New Programmable Logic Editor (PLE) for user-defined control commands
- User-defined macro-based logic without hardware installation
- System optimization & automation
- Automatic generation control
- Security control
- Intelligent feeder & demand management
- Peak shaving
- Cost allocation
- Operator training simulator
- Supervisory & advisory control
- Intelligent inhibition & permissive control

Intelligent Load Shedding

ILS has been improved with many new features, making it faster; less than 90 ms total response time from the initiation of a disturbance. With the new PLE, custom logic compiled and combined with artificial intelligence is easily created. This combination of logics and intelligence provides an optimal load shedding solution that achieves maximum load conservation during transient conditions.

Special handling techniques have been incorporated for islanded systems and power exchange between subsystems. The user interface has been enhanced to enable logic switching and/or load priority schedules without interrupting operations or re-programming devices. Operators can now easily switch schedules based on operating requirements such as summer and winter demands. In addition, specific monitor windows have been added to allow one view to provide a complete status of the system. The Priority Schedule editor has been enhanced to easily define factors that specify significance of individual loads, feeders, etc.

New Capabilities

- Programmable Logic Editor to add user-defined control logics (simple & complex) such as limits, interlocks, permissions, inhibitions, etc.
- New user-friendly editors to define associations & interlocks
- Multiple priority schedules with user-defined sensitivity factors
- User-definable group numbers for optimal breaker selection
- Simultaneous display of the real-time operation & local simulation results
- Easily simulate & validate load shedding commands
- OPC alarm & notification
- Monitor & respond automatically to electrical & non-electrical disturbances
- New user-friendly editors for setting up ILS
- View & print customizable full-color reports
- Monitor “Live” load shedding operation in XML on web page
- Full security access control

Arc Flash

Arc Flash now provides the flexibility to print customizable labels on either Avery® labels or high-end Brady® label printers using new label templates and printing capabilities.

New Features

- Capability to limit incident energy based on maximum Fault Clearing Time (FCT)
- Automatic application of calculated & user-defined FCT simultaneously
- Algorithm for automatic detection of the primary protective device in complex looped networks
- Export results to Excel spreadsheets for interface with third party software & label printers
- New user-interface for defining PPE requirements for each risk category
- Coordinate protective devices using the arc flash incident energy plotted on the TCCs
- New arc flash label templates with user-defined text fields
- New incident energy summary reports

Short-Circuit Analysis

For both ANSI and IEC standards, determine short circuit duty of tie circuit breakers based on the “Maximum Through Fault Current.”

Panel Systems

The Panel Systems module, an intuitive graphical user interface for the design and analysis of low voltage distribution systems, can now export panel data and schedules to third party CAD systems and Microsoft® Excel. The new features include:

- User-definable ground wire fields per branch circuit
- User-definable conduit size field per branch circuit
- Export panel schedules to Excel worksheets
- Five new panel schedule & report templates
- Export panel report & schedule to CAD systems

Harmonic Analysis

A new option has been added that allows you to use long-line model for transmission lines and cables.

Data Exchange

DataX represents a rich set of customizable ETAP interfaces that can be used to bridge gaps between ETAP and other databases.

DataX - Base

The new import tools added to the base package allow you to:

- Import IEEE format files
- Import RAW data files
- Import & export configurations
- Import ground grids from AutoCAD

DataX - Microsoft® Access & Excel

This new module provides the ability to import and synchronize data from Microsoft Excel and Microsoft Access into ETAP.

- Import data from a Microsoft Access table
- Import data from Microsoft Excel worksheets
- Customize data mapping through the graphical user interface
- Automatic data range checking with library data substitution
- Automatic one-line diagram generation
- Intelligent data validation & consistency checking
- Automatic modify & delete actions for existing elements
- View modifications & accept or reject actions

SmartPlant® Interface

The ETAP-SmartPlant interface has been enhanced to allow modification of existing project files from SmartPlant. Major enhancements include:

- Automatic add, modify, & delete actions of elements
- Enhanced one-line diagram generation
- Enhanced element mapping

e-DPP® Interface

The ETAP e-DPP interface now provides:

- Automatic one-line diagram generation
- Enhanced element mapping
- Automatic add, modify, & delete actions of elements

GIS Map

Modify the display of load flow and short circuit results on GIS maps using the new ETAP display options.

Ground Grid Systems

Import ground grid systems from AutoCAD files and automatically set up conductor and grid layouts. Copy and paste grid systems. Calculate touch and step potential outside boundaries.

Get-Set Defaults

The new capability to set and obtain parameters to-and-from element defaults enables parameters to be passed from one element to another.

ETAP Preferences

Now you can apply new preference settings directly from ETAP. Adjust settings in the INI file to customize your ETAP application behavior. These settings are categorized alphabetically or based on an analysis module.

Control System Diagram

The highly capable CSD module streamlines the modeling and simulation of control systems by using a unique state-dependent process that allows you to easily evaluate control logic of new and existing systems. The sequence-of-operation animates the operation of control systems with associated interlocks and controlled devices. This includes elements such as control relays, solenoids, controlled contacts, multi-sequence contacts, push buttons, switches, and actuators. You can select from a large library of control devices to quickly determine pickup and dropout voltages, losses and current flows at various time instances including inrush current. As control devices go through the time sequence and various states, the program provides marginal and critical alerts.

Graphically Animate Control System Operations

New Features

- Graphical animation of complex control logic with or without voltage drop calculation
- Include time-dependent loads of control systems in battery discharge & sizing calculation
- Operator initiated control actions and/or auto-run mode
- Display and alert overloading as well as pickup/dropout voltage violations
- Flexible device modeling with user-defined duty cycle or actual inrush/burden rating
- Validate the voltage requirements of controlling devices
- Generate automatic alerts for pickup & dropout voltage
- View detailed operating states of the devices with the new Event Viewer

Battery Discharge & Sizing

This latest release provides the following new capabilities:

- Automatic simulation of the control system diagrams along with the DC system for battery discharging & sizing calculations
- New option to use a one-minute load span for the battery & load or for the battery alone In addition to the existing ampacity and voltage

Cable Sizing

In addition to the existing ampacity and voltage drop requirements, a new capability has been added to size cables based on short circuit current.

Transmission Line

ETAP 5.5 determines sag and tension for transmission lines on towers with different elevations. Automatic alerts notify when power interchange exceeds derated ampacity of the line.

Transient Stability

The Transient Stability module has been upgraded to present a graphically animated display of the system dynamic response after disturbances. The program is also enhanced for faster calculation speed and plot generations. You can simulate system disturbances and events while performing load shedding, fast bus transfer, critical clearing time, generator start-up studies, and the acceleration or re-acceleration of motors, etc.

New Features

- New sequence-of-operation with interactive time-slider & action list
- New wind turbine generator dynamic models
- New action commands for wind gust, ramp, & noise disturbances
- Apply voltage limits to MOV open & close stages

Motor Operated Valve

Specify critical and marginal voltage limits for motor operated valves (MOVs) for increased control over the simulation process.

- User-defined voltage limits during start, seating/unseating, and travel time
- Select the MOV voltage alert based on MOV rated voltage or voltage limits for different stages

Optimal Capacitor Placement

The Optimal Capacitor Placement module is a sophisticated enhancement to ETAP 5.5 with the capability to strategically place capacitors for voltage support and power factor correction. OCP provides performance and cost analysis that can substantially minimize installation and long-term operation expenses. The advanced graphical interface allows for quick creation and modification of your capacitor placement design. The precise calculation approach automatically determines the best locations and bank sizes. You can view and present results in an easy-to-understand visual format.

New Features

- Calculate the most cost-effective installation locations & bank size
- Calculate return on investment for the entire planning period
- Consider voltage support & power factor correction objectives
- Generate reports & plots of capacitor operating profit
- Handle unlimited network configurations
- Options to constrain installation locations with user-defined parameters
- Option to constrain the maximum number of capacitors installed at any location
- Use both individual & global constraints
- Utilize individual source or global energy costs
- Evaluate the capacitor installation for various system loadings

Configuration Manager

The Configuration Manager provides a tabular view of individual device status and allows you to view, control, and manage the status of all elements from one editor. This dynamic new feature adds increased flexibility to change, track changes, and compare status of devices. For example, intelligent filtering isolates specific open protective devices making it easy to locate on the one-line diagram. Additional filtering exposes differences between configurations in a fraction of the time normally associated with one-line diagram monitoring.

New Features

- Manage & view configuration status of devices at a glance
- Identify differences between configurations for better visual understanding
- Option to filter & display specific configurations & device types
- Options to customize display status
- Directly modify the status of multiple devices
- Create, copy, delete, & rename commands
- Export configurations to Microsoft Access tables for further queries & reporting

Configuration Checking

In addition to the properties (elements in the project) and library data, you now can check and validate configuration status of elements.

Theme Manager

The Theme Manager allows you to create and recall templates for the graphic display of elements, connectors, annotations, results, alerts, and background colors. You can graphically distinguish phase connections (such as A, C, D, 1-phase, 2-phase, 3-phase, 2W, 3W, 4W, etc.) by changing the connector style and colors. This highly versatile interface permits customization at nearly every level. This includes the flexibility to select from existing templates, Microsoft Windows environment, or personalized themes. A significant advantage of the Theme Manager is that unlimited project-independent custom styles may be stored on a computer and are readily available when you switch from one ETAP project to another.

New Features

- Instantly create or switch between multiple color schemes using theme templates
- Pick a background color for the best contrast when viewing one-lines, performing system studies, or real-time monitoring
- Set different themes for individual one-line diagrams
- Flexible coloring for AC & DC elements, annotations, & composite networks
- Assign highly visible colors for alerts, alarms, & warnings
- Easily differentiate between 1-phase, 2-phase, & 3-phase systems
- Modify the element, grid, & background colors for specific presentations
- Easily set colors based on voltage levels

License Administrator & Wizard

Maintain optimal productivity and receive the greatest value from ETAP resources by monitoring and administering access to your ETAP license. This new tool provides an at-a-glance view of all the computers and users online with ETAP. It even keeps track of how long they've been logged online. The License Wizard can switch access to different ETAP License Managers. Productivity bottlenecks can be avoided by scheduling user access when demand exceeds the number of

- Identify all users logged onto ETAP
- Minimize accessibility conflicts
- Manage ETAP licenses via License Wizard

Output Reports

Viewing output reports and plots is now even easier. The new Find feature allows you to locate specific information fast. Simply select an element type from a listing of element IDs, then choose the ID you wish to review and search the report for occurrences of the selected ID. Examine the report electronically in the viewer or save the data in a format that can be opened by a spreadsheet program. Experience faster operation and easier access to your report data. Other enhancements include:

- Find elements or text
- Reports can be exported in five common spreadsheet & word processing formats

Text Box

- Add text in user-defined areas on one-line & control system diagrams
- Select the font, size, & color of text
- Modify the shape & opacity of a text box
- Edit appearance of text boxes for print output or electronic presentations
- Default text box settings

ETAP License Option - Advantage

The new license option "ETAP Advantage" is now available in response to the increased demand from customers and consultants in a variety of industries requesting additional quality assurance documentation.

With the "ETAP Advantage" option, you receive the following additional documentation and services:

1. Verification & Validation Certification Letter which states that ETAP is verified and validated per the requirements of ISO 9001:2000, Title 10 CFR 50, Appendix B, Title 10 CFR Part 21, ANSI/ASME N45.2, ASME NQA-1, ANSI/IEEE Std 730.1, CAN/CSA-Q 396.1.2, and ANSI N45.22.
2. Performance Reporting will keep you updated with program deviations, limitations, and detailed listing of changes from one release to the next. Deviations are reported within five working days from discovery. Reporting includes minor deviations in calculations, library data, program interface, output reports, plots, project database, etc. Major/substantial errors are reported to all ETAP users.

ETAP Advantage is beneficial for all types of industries and consulting firms

- Eliminate man-hours & expense of internal software verification & validation
- Take advantage of a well established & credible QA program (since 1991)
- Gain proof of software & library accuracy with minimal investment
- Receive formal notification of program & library deviations & limitations
- Receive a complete listing of program enhancements & changes with each new release



Operation Technology, Inc.
17 Goodyear, Suite 100
Irvine, CA 92618-1812
(949) 462-0100
Fax: (949) 462-0200
Support: (949) 462-0400
Email: support@etap.com
www.etap.com

ETAP 5.0.3

August 17, 2005

The OTI Engineering and Development Teams are pleased to present you with the latest ETAP 5.0.3 release. ETAP 5.0.3 is a point release, which includes a number of fixes for the ETAP 5.0.2 release. ETAP 5.0.3 CD is a complete program and does not require any previous ETAP installation.

We recommend that you utilize this latest release in order to take advantage of the new features and capabilities. We strive to provide our customers with advanced features and industry standard engineering tools.





Operation Technology, Inc.
17 Goodyear, Suite 100
Irvine, CA 92618-1812
(949) 462-0100
Fax: (949) 462-0200
Support: (949) 462-0400
Email: support@etap.com
www.etap.com

ETAP 5.0.2

May 24, 2005

The OTI Engineering and Development Teams are pleased to present you with the latest ETAP 5.0.2 release.

ETAP 5.0.2 is a point release, which includes several enhancements and corrections for the earlier 5.0.1 and 5.0.0 releases. ETAP 5.0.2 is a complete program and does not require any previous ETAP installation. We recommend that you utilize this latest release in order to take advantage of the new features and capabilities. We strive to provide our customers with advanced features and industry standard engineering tools.

For more information about this new release, please take a few moments to read and review the information below.

Arc Flash Module - IEEE 1584

- 1) Automatic determination of all the Source and Load Protective Devices (PDs) for a faulted bus. Source PDs are defined as PDs that are upstream to a faulted bus, through which fault current contributions flow from generators and/or power grids. The program searches all radial branches connected to the faulted bus, up to three bus levels away until multiple source branches are found. The default number of 'bus levels away' can be changed to a maximum of 20 levels in the *etaps.ini* file.
- 2) Enhanced Arc Flash page of Bus editor with new layout and features.
- 3) Added user-defined Source PDs capability to each bus. This allows more flexibility for the determination of the fault clearing time.
- 4) Enhanced one-line diagram for display of results and the output reports to include the working distance and warning flags.

IEC Short-Circuit Module – IEC 60909-0

- 1) Added capability to the two-winding transformers to select a unit generator to form a power station unit.



Before performing calculation, users need to identify the unit transformers for power station units. By doing this ETAP then automatically determines all the elements within the power station units including their auxiliary systems, as well as network elements as defined by IEC 60909 Standard.

- 2) Enhanced the calculation of the breaking current (I_b) according to the adjustments described in equation (75), page 115 of IEC 60909-0. The effect of equation (75) will reduce the breaking current slightly. Note that this adjustment is considered optional and applies only to near generators faults in mesh systems.

Device Coordination / Selectivity – Star

- 1) Enhanced the Star view interface for speed and printing compatibilities.
- 2) Enhanced the data conversion program from PowerPlot to ETAP Star.

Library – etaplib502.lib

- 1) Released etaplib502 library including new protective device library models.
- 2) Validated and Verified (V&V) library data per OTI's Quality Assurance program.
- 3) Changed Kerite Cable library data (cable reactance for magnetic installation).
- 4) Added Kerite Cable library data for non-magnetic installation.
- 5) MV Solid State Trip Relay (Long Time Curve) has been updated.
Manufacturer: Westinghouse, Models: DigiTrip 3000, DigiTrip MV.
- 6) Implemented a library release number (versioning) for newly issued libraries for the purpose of library merge.
- 7) Enhanced library copy and paste capabilities.
- 8) The following time-current characteristics fuse curves were enhanced by digitizing the manufacturer curves:

Manufacturer	Model	Size
Chance	Fuse Link (K), Fast speed	All
	Fuse Link (T), Slow speed	All
	Fuse Link (SloFast), Slow speed	All
Cooper	NXC (8.3, 15.5, 23 kV)	All
Siemens	FM (2.54 kV, 5.08 kV)	All
General Electric	9F60 EJO-1 (2.75 kV, 5.5 kV)	All
	9F60 EJ-1 (2.75 kV, 5.5kV)	
Gould Shawmut (Ferraz)	A2D (0.25kV), Speed: Time Delay	70R, 80R, 90R, 100R
Mitsubishi (IEC Fuse)	CLS (Style R) (2.75 kV, 3.6 kV, 5.5 kV, 7.2 kV)	All

9) Corrected the interrupting ratings for the following fuses:

Manufacturer	Model (kV) (All Sizes & Speeds)	Manufacturer Data Interrupting Rating (kA Sym.)
Bussmann (DC Fuse)	LP-CC (150 V, 300 V), Time Delay speed	20
Cooper	FL23R (7.2 kV), FL8R (7.2 kV)	3.5
	FL8R (14.4 kV)	1.8
	Tandem ELF (27 kV)	43
Cutler-Hammer	CLE (1/03) (8.3 kV), sizes 150E and 175E only	50
Driescher	DRK 07 (7.2 kV)	40
Gould Shawmut (Ferraz) (DC Fuse)	FESF (460 V)	40
S&C	Fault Fiter (Uni-Rupter) (29 kV)	12.5
	SMD-1A (48.3 kV), Size 1A, Standard speed only	13.1
Siemens	A500 (2.54 kV, 5.08 kV)	50
	A720 (7.2 kV)	
	FM (2.54 kV, 5.08 kV)	



Operation Technology, Inc.
17 Goodyear
Irvine, CA 92618-1812
(949) 462-0100
Fax: (949) 462-0200
Support: (949) 462-0400
E-mail: support@etap.com
www.etap.com

ETAP 5.0

September 2004

The OTI Development Team is pleased to provide you with the latest ETAP 5.0 release. ETAP 5.0 is a major upgrade to ETAP 4.7.6.

The new 5.0 release includes major enhancements to existing modules as well as several new analysis modules, including ETAP Star, which is a new concept for protective device coordination and protection. ETAP Star has been in design and development for the last two years, and we are very excited about sharing its features and benefits with our users.

ETAP 5.0 – System Requirements

Operating System

- Microsoft® Windows 2000 (Service Pack 3 or higher) Professional or Server
- Microsoft® Windows® XP (Service Pack 1 or Higher)
- Microsoft Server 2003

Software Requirements

- Internet Explorer 5.01 or higher
- Microsoft .NET Framework v1.1

PC Configuration Requirements

- Parallel Port, USB Port, or Serial Port (for Stand-Alone Licensing only)
- CD-ROM or DVD Drive
- 5 to 80 GB Hard Disk Space (Based on Project Size, Number of Buses)
- 19" Monitors Recommended (Dual Monitors Highly Recommended)

Real-Time Application - PSMS Server

- Intel Pentium IV Xeon – 3.0 GHz with Symmetrical Multi-Processing (Dual)
- Hyper-Threading Technology & 533 MHz System Bus
- 2 to 8 GB RAM - (RDRAM or High-Speed DDR RAM)

System Configuration

Projects Less Than 500 Bus

- Intel Pentium IV – 2.0 GHz
- 512 MB of RAM

Projects Less Than 2,000 Bus

- Intel Pentium IV – 2.2 GHz with 512 KB L2 Cache, or Intel Pentium IV – 3.0 GHz with Hyper-Threading Technology
- 1 GB of RAM (RDRAM or High-Speed DDR RAM)

Projects Over 2,000 Buses
(10,000/20,000/30,000/Unlimited Buses)

- Intel Pentium IV Xeon – 3.0 GHz with Symmetrical Multi-Processing (Dual)
- Hyper-Threading Technology & 533 MHz System Bus
- 2 to 8 GB RAM - (RD RAM or High-Speed DDR RAM)

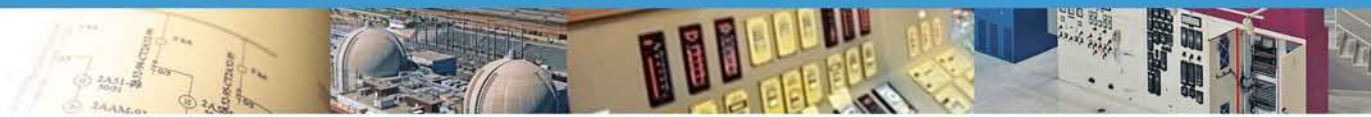

ETAP Star New Module (Device Coordination/Selectivity)

ETAP Star is an advanced concept in performing steady-state and dynamic coordination and selectivity of protective devices. This is achieved by utilizing intelligent one-line diagrams, comprehensive device libraries, and an integrated three-dimensional database. Designed and developed by OTI, Star is a fully integrated module within ETAP, with built-in analyses such as short-circuit and motor acceleration.

ETAP Star Features Include:

- Graphically Adjustable Device Settings
- Sequence-of-Operation of Protective Devices
- Embedded Fault & Motor Acceleration Analyses
- Extensive Device Library (Verified & Validated)
- Phase & Ground Coordination Modes
- Multi-Function Universal Relays (50/51 P, N, G, SG, 51V, 67, 46, & more)
- Built-In Interface with Relay Hardware
- Display Actual Relay Transient Response
- User-Definable Device Library Database
- Fixed Point / Damage Curve Modeling
- Graphical Time-Difference Calculator
- Automatic Current & Voltage Scaling of TCC View
- Advanced Curve-Fitting Algorithms
- Auto Clipping for All Protective Devices
- Click & Drag Curves to Adjust Settings
- Automatic Layout of the One-Line Diagram in Star View
- Print or Plot on Multiple Pages
- Automatically Shrink to Fit on a Single Page
- Print or Plot to Various Paper Sizes, Including Full Size Plotters
- Print Comprehensive Reports of Input Data & Study Results
- Customizable Print Functionality, Legends, & Device Labeling
- Display Input Data & Study Results on the Drawing

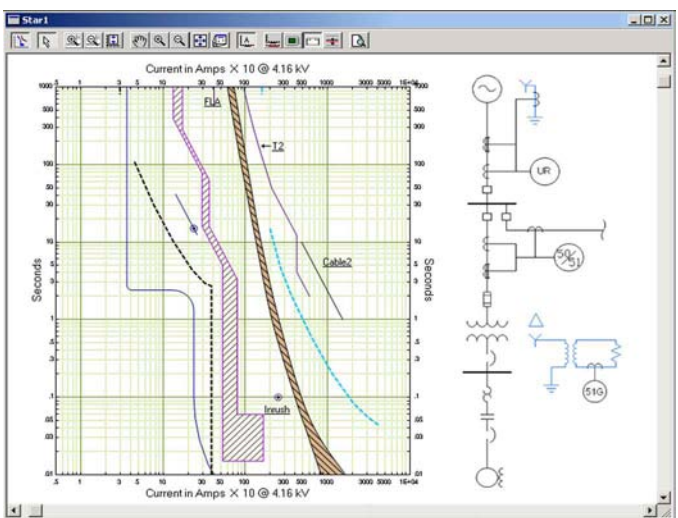

Star Sequence-of-Operation New Concept

ETAP Star Sequence-of-Operation provides a system wide solution for accurate and realistic operating times and states of protective devices, such as relay, fuse, circuit breaker, trip devices, contactor, etc. The operation time is calculated for each protective device based on its settings, time current characteristics, and interlocks for a specified fault location and type.

With ETAP Star, not only can you work with the time-current curves, you can also determine the operating time of protective devices simply by placing a fault on the one-line diagram.

- Automatically calculate and display the fault current contributions on the one-line diagram
- Graphically place a fault anywhere on the one-line diagram
- Determine the operating time and state of all protective devices based on the actual fault current contribution flowing through each individual device
- Globally view post fault actions and associated operating time via a tabulated Event Viewer
- Graphically examine the operation of protective devices via the one-line diagram

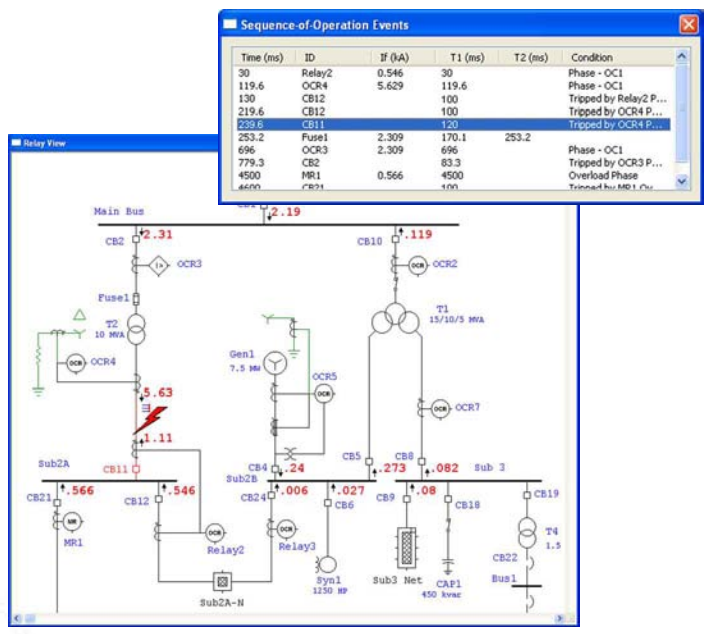

Coordinate via One-Line Diagram

Optimal Capacitor Placement

Optimal Capacitor Placement allows engineers to strategically place capacitors for voltage support and power factor correction while minimizing installation and long-term operation costs. The advanced graphical interface gives users the flexibility to control the capacitor placement process and graphically view the results. The precise calculation approach automatically determines the best locations and bank sizes. In addition, it reports the branch capacity release and the estimated savings during the planning period due to var loss reduction.

- Best Location & Bank Size
- Minimum Total Installation & Operation Cost
- Voltage Support & Power Factor Correction
- Branch Capacity Release & Cost Savings
- Capacitor Control Method
- Review Capacitor Impact on the System

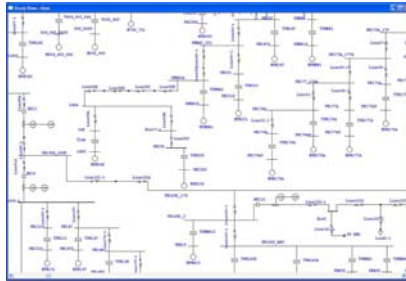

Unbalanced Load Flow

A robust and efficient power flow solution method must be able to model special features of distribution systems with sufficient accuracy. With ETAP's Unbalanced Load Flow module, you can easily model your unbalanced system with detailed representation of component unsymmetrical characteristics. Accurate and reliable per-phase results are available to describe your system's unbalanced operating conditions. Automatic alarms/warnings and advanced features such as the automatic line constant calculator make it the most advanced Unbalanced Load Flow program available today.

- Advanced Current-Injection Method
- Looped & Radial Systems
- 1-Phase, 2-Phase, & 3-Phase Unbalanced Load Flow
- Unbalanced Branch & Load Modeling
- Transmission Line Coupling
- Charging Current for Open-End Branches
- Phase & Sequence Voltage, Current, & Unbalanced Rates
- Multiple Demand Factor Non-Linear Loads
- Real & Reactive Power Losses & Voltage Drop Calculation
- Line & Cable Temperature Correction
- Automatic Alert for Device Evaluation

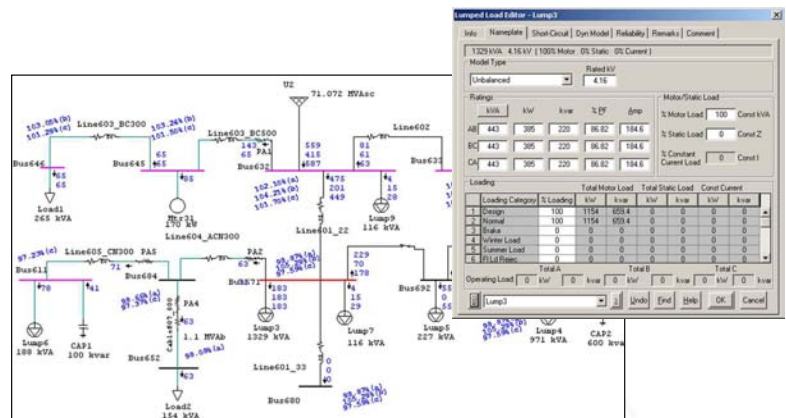

Control System Diagram

ETAP seamlessly integrates power and control systems within one electrical analysis program. The Control System Diagram (CSD) simulates the sequence-of-operation of control devices such as solenoids, relays, controlled contacts, multi-sequence contacts, and actuators including inrush conditions. CSD has the capability to determine pickup and dropout voltages, losses, and current flows at any time instance as well as overall marginal and critical alerts. A large library of equipment enables engineers to quickly model and simulate the action of relays associated with control interlocks after time delays.



Simulate Control Actions just like in Real Systems

- Drag & Drop Control Relays, Solenoids, Contacts, Cables, etc.
- Control Logic Simulation (Relays, Circuit Breakers, Contacts, etc.)
- Voltage Drop Calculation including Inrush Currents
- Battery Discharge Calculations using Actual Control Logics
- Automatic Alert for Pickup & Dropout Voltages
- Automatic Overloading Alerts
- Fully Integrated with One-Line Diagrams
- Comprehensive Device Library (Verified & Validated)



GIS Map New Module (Geographic Information System)

ETAP GIS Map superimposes electrical one-line diagrams with the corresponding geographical maps of power generation, transmission, and distribution systems. Synchronize relevant electrical equipment information from GIS into ETAP and maintain the relationship between them.

- Data Synchronization with GIS
- Embedded Load Flow & Fault Analyses
- Display Analysis Results on GIS Maps
- Display Unlimited GIS Presentations
- Perform Add, Modify, or Delete Actions
- View ESRI ArcGIS® Maps in ETAP
- Use Map Tools – Zoom In, Zoom Out, Full Extent, Pan, etc.
- Fully Control Analysis Results Displayed on the GIS Map
- Map GIS Equipment Attributes to ETAP Element Attributes
- Perform Data Consistency Checks

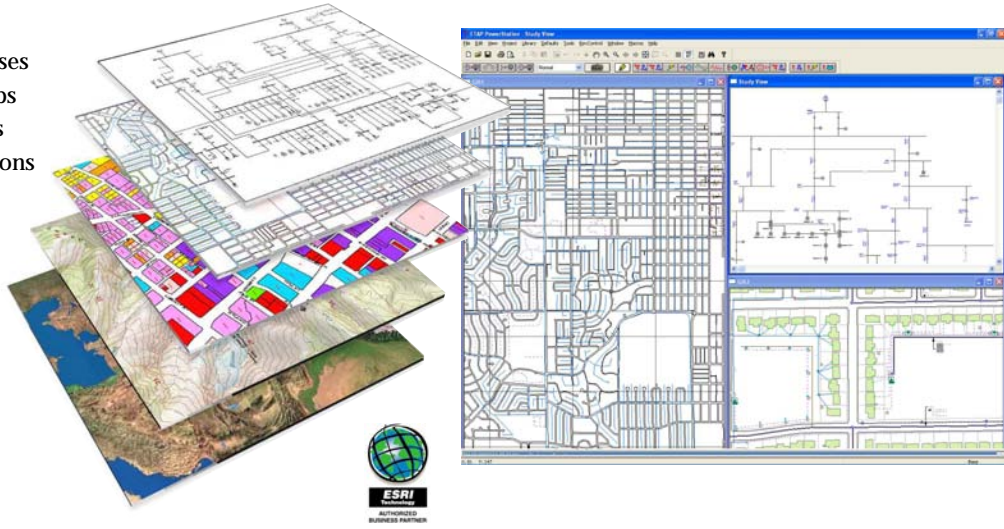

Transmission Line New Module

The new Transmission Line editor provides new configuration templates for automatic calculations of line constants. You can enter the line data or select from the newly-added transmission line library, for phase conductors and ground wires. The editor calculates conductor ampacity-temperature relationships, and sag and tension-temperature relationships of overhead transmission lines.

Line Ampacity New Module

- Line Ampacity Derating
- Conductor Operating Temperature Calculation
- Wind Speed & Direction Elevation, Latitude, Sun, & Solar Effects Absorptivity & Emissivity
- Ambient & Operating Temperatures



Sag & Tension New Module

- Multiple Suspension Spans Between Dead-End Structures
- Multiple Spans of Unequal Lengths
- Wind, Temperature, Ice, & k Factor Effects



ETAP Wizard New Module (Added to Base Modules)

ETAP 5.0 includes a time saving project management tool known as the ETAP Wizard, which enables you to record and automatically run hundreds of different studies at any time. The ETAP Wizard consists of a Scenario Wizard, a Study Wizard, and a Project Wizard.



- Manage & Automate Studies for Multiple Projects
- Save Study Parameters & Settings
- Run Multiple Scenarios On-Demand
- Use Macros to Automate & Repeat Studies

NEW Elements



Static Var Compensator (SVC)

- Capacitive & Inductive Characteristics
- Modeling Within & Outside Control Range
- Full Controller Dynamic Modeling
- Several Typical Control Models

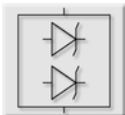

High Voltage DC Transmission Link (HVDC)

- Load Flow Modeling
- Different Combination of Operating Modes for Rectifier & Inverter
- Full AC/DC Controllers Dynamic Modeling
- Current, Power, & Voltage Controllers for Rectifier & Inverter
- Voltage-Dependent Current-Order Limits (VDCOL) Control Model
- Shut-Off & Re-Start Models



Multi-Function (Universal) Relay

- Multi Level & Function
- Overcurrent (50/51)
- Voltage Control/Restraint (51V)
- Phase, Neutral, Ground, Sensitive Ground, & Negative Sequence
- Directional Overcurrent (67)
- Overload (49)
- Multiple CT & PT Connections
- Multiple Circuit Breaker Interlocks



Overload Heater & Relay

- In-Line, CT Connected, & Solid State
- Minimum & Maximum Resistances
- Automatic Voltage Drop Calculation for Connected Loads
- Resistance Tolerance



Text Box

- Graphically Display Text & Element Properties
- Automatic Updates with Change of Properties
- Display on One-Line Diagrams, Underground Raceway Systems, Control System Diagrams, Star Views, etc.



Grounding Elements

- Intelligent One-Line Diagrams
- Generators, 2W & 3W Transformers
- Connect Instrument Transformers, Relays, & Meters
- Hide & Show On-Demand per Presentation

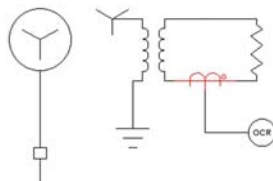

Enhanced Elements



Generator

- Generation Category • PF Control Mode
- MW-Mvar Capability Curve • X_d'' Tolerance
- Inertia Calculator (Prime Mover, Coupling Gear, & Generator)
- Shaft Torsion Parameters • Engine Rating
- Grounding Through Distribution Transformer
- Graphical Grounding Elements on One-Line Diagram

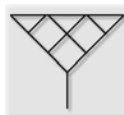

Power Grid

- Generation Category
- PF Control Mode



Bus

- Arc Flash Parameters Based on Normal kV
- Unbalanced Initial Voltage
- Arc Flash Calculator with Embedded Fault Analysis & Protective Device Clearing Time



Lumped Load

- Unbalanced Loading
- Dynamic Model
- Voltage & Frequency Dependent Models (Exponential, Polynomial, & Comprehensive)

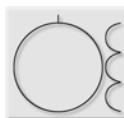

Induction & Synchronous Motors

- Inertia Calculator (Motor, Coupling Gear, & Load)
- Shaft Torsion Parameters
- Point-by-Point Load Model
- Partial-Winding, Y- Δ , Rotor External Impedance, & Soft Starters (Current, Voltage, & Torque Control)



Transmission Line

- Multi-Distance & Multi-Line Coupling
- Tower Arrangement with Multiple Templates
- User-Defined Conductor Configurations
- Transposition & Multi-Layer Earth



Transformer (2W & 3W)

- Grounding Through Distribution Transformer
- Graphical Grounding Elements on One-Line Diagram



ENHANCED MODULES

Added Features to all Modules

Thanks to user feedback, significant additions and improvements have been made to enhance all network analyses modules. These enhancements include various study options to globally change and adjust system parameters and topology with a click of the mouse to increase your productivity.

- Individual and/or Global Tolerance (Length and/or Impedance) for Cables, Transmission Lines, OLH, Transformers, & Reactors
- Isolated Subsystem Index
- Parameter Adjustment Report
- Generation Category
- Transmission Line Coupling
- Protection Page (Cable, Transmission Line, Transformer, Generator, Induction Motor, Synchronization Motor)
- Charging Current for Single-End Open Branches (Cable, Transmission Line, & Impedance Branch)
- New One-Line Diagram Zoom
- Enhanced Connection Logic for One-Line Diagram
- UPS Output Connection

Short-Circuit

We have enhanced the IEC Standard for device evaluation based on maximum fault current through protection devices, and reporting of braking current as a function breaker time delay. ETAP 5.0 also provides detailed reports and graphical display of line-to-ground, line-to-line, and line-to-line-to-ground fault currents.

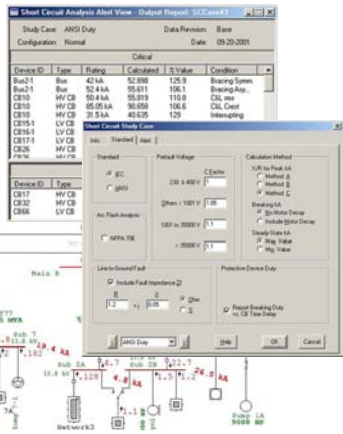

Load Flow

ETAP's advanced Load Flow module includes features such as automatic device evaluation, summary alarms/warnings, and intelligent graphics. Already a robust power calculation tool, the module has enhanced device evaluation, alerts, and reporting.

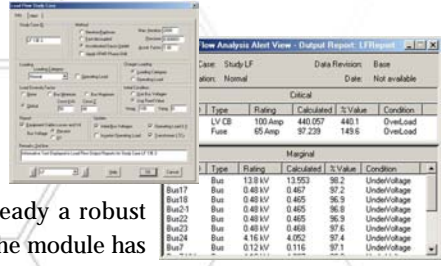

Motor Acceleration

The Motor Acceleration module has been enhanced to reduce the time it takes to conduct single and group motor acceleration studies. Major enhancements include the new soft starters (control motor voltage, current, or torque), alerts (report various violation for motors, buses, generators, and engines), unlimited time events, and user-defined point-by-point motor load modeling features.

- Partial-Winding, Y- Δ , Rotor External Impedance, & Soft Starters
- Comprehensive Alert View
- Unlimited Number of Events
- Point-by-Point Motor Load Model
- Plots for Static Loads & Buses
- Source Voltage Sequencing

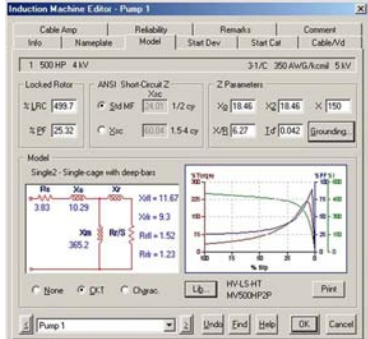

Arc Flash



ETAP Arc Flash Analysis estimates the arc flash incident energy under a bolted 3-phase short circuit fault and determines the flash protective boundary to live parts for shock protection. Design safer power systems by insuring compliance with OSHA 29 CFR 1910.132(d) 1990, NFPA 70E-2004, and IEEE 1584-2002 Standards.

- System Calculated or User-Defined Fault Current
- System Calculated or User-Defined Arcing Fault Clearing Time (Interface with ETAP Star)
- System Calculated or User-Defined System Grounding
- Arcing Current Variation
- Automatic Determination of Hazard/Risk Category for PPE
- Create Regulation Arc Flash Hazard Labels for Every Bus
- Different Label Templates Available for Each Faulted Equipment
- Quick Incident Energy Calculator (Bus Arc Flash Page)
- User-Defined Equipment Gap Between Conductors & X Factors
- Limited Approach Boundary Based on NFPA 70E Table 2-1.3.4
- Added Arc Flash Calculation Icons to the Short-Circuit Toolbars
- Automatically Update Arc Flash Analysis Results to Every Bus

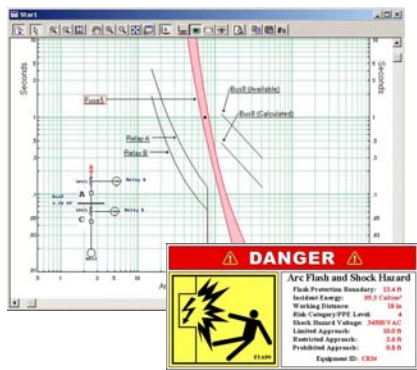

ENHANCED MODULES

Transient Stability

The Transient Stability module has been dramatically expanded to increase the type of transient actions (disturbances, load and generation changes, relay actions, etc.) you can place on the system. Among the many added features are SVC, multi-mass shaft modeling, synchronous motor acceleration with discharge resistor, and automatic assignment of reference machine for each isolated subsystem.

- Partial-Winding, Y- \bullet , Rotor External Impedance, & Soft Starters
- Motor Point-by-Point Load Model • HVDC Transmission Link
- Dynamic Model for Lumped Load • Universal Relay Actions
- SVC (Steady-State & Transient Response)
- Transformer LTC Initial & Operating Time Delays
- Enhanced General Models for Lumped Load
- Synchronous Motor Acceleration with Discharge Resistor & Pull-in Process
- Step & Ramp Changes of Generation Level, and AVR Reference Voltage
- Step & Ramp Changes of Synchronous & Induction Motor Loading
- Enhanced Fractional Branch Faults (Transmission Line, Cable, & Impedance)
- System Zoning & Automatic Reference Machine Assignment for Each Islanded Subsystem
- New Plots
 - Absolute Power Angle for Synchronous Generators & Motors
 - Generator & Motor Mvar Flows
 - Terminal Voltage for Synchronous & Induction Motors
 - Difference of Variables for Fast Bus Transfer
- Contactor Open & Close Action
- Start Synchronous & Induction Motors by Starting Category
- Multi-Mass Shaft Model for Generators & Motors
- New Bus Frequency Calculations using Electrical Distance Method

ETAP Real-Time (PSMS)

Built on ETAP, the world-leading power system analysis software, ETAP Real-Time is a real-time energy management system used by operators and managers to monitor, control, and optimize power systems.

- Enhanced State Estimator & Load Distribution
- PF Meters
- New Real-Time Simulation Modules
- Enhanced Intelligent Load Shedding
- Extended Communication Protocols

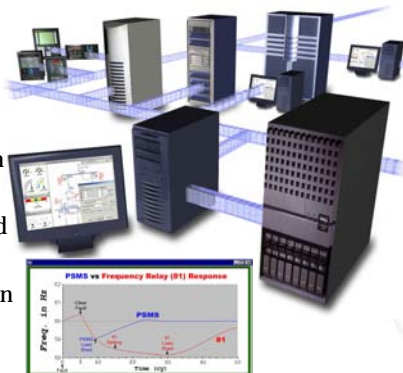

Harmonics

The new Harmonic Analysis module helps you quickly identify problems, reduce nuisance trips, design and test filters, and distortion limit violations alerts. The module provides comprehensive load flow and frequency scan calculations using detailed harmonic models and non-integer harmonic filters.

- New Harmonic Filters
- Transformer k Factor Rating
- Alerts for VTHD, VIHD, Transformer, Filter, Capacitor, & Cable
- Report Resonance Frequencies & Magnitudes
- Enhanced General Models for Lumped Load
- One-Line Display of Capacitor & Filter Current
- Generation of Harmonic Sources Based on Device Parameters for VFD, UPS, Charger, & Inverter

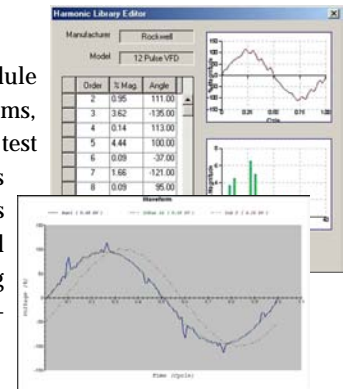

Libraries (New & Enhanced)

OTI has enhanced and created many new libraries with data locking and checker capabilities. Also for ETAP 5.0, all libraries related to protective devices are combined (short-circuit ratings and time current characteristics) into one ETAP library. The new library has been validated and verified based on published manufacturer data per ETAP's quality assurance program.

- Control Relay • Solenoid
- LV Circuit Breaker • Fuse
- Overload Relay & Heater
- Point-by-Point Motor Load Characteristics
- Transmission Line Library (Phase & Ground Conductors)
- Trip Devices (Solid State, Thermal-Magnetic, Electro-Mechanical, & Motor Circuit Protector)
- Multi-Function (Universal) Relay (50/51 P, N, G, SG, 51V, 67, 46, ...)

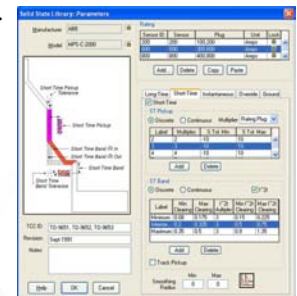

New Protective Device Library

- | | | |
|-------------------------|-----------------------------|--------------------|
| • ABB (BBC) | • Federal Pioneer | • Protecta |
| • AEG | • Fuji Electric | • RTE |
| • Allen Bradley | • G&W | • S&C |
| • Allis-Chalmers | • GE Multilin | • Schlumberger |
| • Alstom | • GEC Alstom | • Schweitzer (SEL) |
| • Basler Electric | • General Electric | • Siba |
| • Brush | • Gould Shawmut (Ferraz) | • Siemens |
| • Bussmann | • Heinemann | • Snemo |
| • Carriere | • ITE (BBC) | • Southern States |
| • CEE | • Joslyn | • SPD Technologies |
| • Chance | • K Moeller | • Square D |
| • Combined Technologies | • Kearney | • Sure-Trip |
| • Cooper | • KyongBo Electric | • Sylvania |
| • Cooper (Edison) | • L&T | • Sytek |
| • Cutler-Hammer | • LG | • Terasaki |
| • Deesys | • McGraw-Edison | • Toshiba |
| • Dorman Smith | • Merlin Gerin | • Universal |
| • Driescher | • MicroelettricaScientifica | • Utility Relay |
| • Enertec | • Mitsubishi | • Westinghouse |
| • English Electric | • Moeller | • Xelpower |
| • Federal Pacific | • P&B Engineering | • ZIV |



ETAP PowerStation 4.7.6

January 2004

The OTI Development Team is pleased to present you with the latest ETAP PowerStation 4.7.6 and PowerPlot v2.5, Release 167. ETAP PowerStation 4.7.6 is a point release, which includes some enhancements and corrections for earlier releases.

ETAP PowerStation 4.7.6 release is a complete program and does not require an earlier program installation.

ETAP PowerStation 4.7.4

June 2003

Continuing our tradition of providing quality products, the OTI Development Team is pleased to present you with the latest ETAP PowerStation 4.7.4 and PowerPlot v2.5, Release 134. ETAP PowerStation 4.7.4 includes minor enhancements and corrections from our 4.7.0 release and incorporates the following new module and features:

- Arc Flash Analysis using IEEE Std. 1584-2002 method
- Hyperlink
- Auto Project Backup

We encourage you to install this latest release to take advantage of the new features and capabilities. Please contact OTI sales to purchase the new Arch Flash IEEE 1584 module. We are excited about providing our customers with advanced features and industry standard engineering tools.

For more information, please take a few moments to read and review the information below:

Arc Flash IEEE 1584 Analysis NEW MODULE

The new ETAP module Arc Flash Analysis uses the IEEE Std. 1584-2002 method to estimate the arc flash incident energy under a three-phase short-circuit fault and determines the flash protective boundary to live parts for shock protection. The flash protection boundary is the distance a worker without wearing flame-resistant personal protective equipment (PPE) must keep from equipment, which may cause hazardous arc flash.

In the IEEE Std. 1584-2002 method, the empirically derived model is used for voltages in the range of 0.208-15kV. The theoretically derived Lee Model is used for voltage levels above 15kV. The empirically derived model has a bolted fault current range of 0.7- 106kA. ETAP Arc Flash is available for both ANSI and IEC Standards.

Arc Flash Analysis with NFPA 70E-2000 Standard continues to be an integral part of the ETAP Short Circuit Analysis module.



Hyperlink NEW FEATURE

- Drag and drop the hyperlink on any device on the one-line diagram, raceway, or presentation including composite motors and networks.
- Hyperlinks Editor opens automatically after dropping link onto an element or one-line diagram.
 - Description
 - Web or network address of file
 - Tooltip (Roll-over)
- Multiple links per element are possible. Hyperlinks are easy to edit and remove.

Auto Project Backup NEW FEATURE

In order to maximize protection of your PowerStation projects and prevent loss of data due to hardware or network failure, PowerStation is enhanced to maintain backup copies of project files. These backup files are created when any of the following actions are performed:

- Conversion creates a back-up copy of current database prior to conversion.
- Opening a project: creates a temporary back-up copy after opening a project session.
- Closing a project: auto-saves backup file when closing a project session.

The auto backup feature can be turned off in the ETAPS.INI file. The default setting is set to “1” to create backup. To stop auto-backup functions, set the INI file value to “0”.

```
[ETAP PowerStation]  
CreateBackupFile=0
```

Data Exchange

DXF file format is optimized. File size for each DXF file is considerably less if the file contains minimal information.



System Requirements

Minimum Hardware Requirements

Your computer must meet the following **minimum** hardware requirements to run PowerStation 4.7.4:

- Intel Pentium III
- 256 MB of RAM
- 500 MB available hard disk space
- Parallel, USB*, or Serial* Ports (*PowerPlot licensing not available for these ports)
- CD ROM Drive – Stand Alone Licensing only

Operating System

Your computer must meet the following Operating System and software requirements to use PowerStation 4.7.4:

Microsoft® Windows®

- 98®SE (Second Edition)
- NT™ 4.0 (Service Pack 6 or higher)
- XP
- 2000 (Service Pack 2)
- Me™
- Internet Explorer 5.0 or higher

Recommended Hardware Requirements

For projects less than 500 busses

- Intel Pentium IV or higher – 2.0 GHz or higher
- 512 MB of RAM
- 20 GB disk space
- Dual 21" monitor with 1024x768 resolution
- Microsoft® Windows® 2000 Professional, XP Professional, XP Home

For projects less than 2,000 busses

- Intel Pentium IV or higher – 2.2 GHz or higher with 512 kb L2 cache. Intel Pentium IV w/Hyper-Threading technology recommended (3.0 GHz or higher).
- 1 GB of RAM (RD RAM or High-speed DDR RAM)
- 40 GB disk space.
- Dual 21" monitor with 1024x768 resolution, or higher
- Microsoft® Windows® 2000 Professional, XP Professional

For projects over 2,000 busses (10,000, 20,000, 30,000, or unlimited busses)

- Intel Pentium IV Xeon (3.0 GHz or higher) w/Symmetrical Multi-Processing (Dual) and Hyper-Threading Technology. 533 MHz System Bus.
- 2-8 GB RAM, depending on maximum number of busses - (RD RAM or High-speed DDR RAM)
- 80 GB disk space
- Dual 21" monitor with 1024x768 resolution, or higher
- Microsoft® Windows® 2000 Professional, XP Professional

Future Software Requirements

The ETAP 4.7.4 series will be the final release supported in the Windows 98, ME, and NT operating systems. Future releases will require either Windows XP or 2000. In addition, ETAP will require that Microsoft .NET runtime package be installed.



ETAP PowerStation 4.7.0

October 2002

This release incorporates Cable Pulling, Transformer MVA Sizing, Transformer Tap Optimization, IEC 287 temperature analysis (Underground Raceway Systems), and Motor Parameter Estimation modules into ETAP, making ETAP completely integrated within the Windows environment. In addition, hundreds of enhancements have been added to the existing modules.

Following the tradition of ETAP integration of electrical and physical properties, the newly added modules have been designed to fully integrate with existing modules to eliminate multiple instances of the similar data. For example, the Cable Pulling module uses the data from the existing cables in your ETAP project files. Thus, the data for a single cable can be used for:

- ✓ Network analyses such as load flow, short-circuit, etc.
- ✓ Cable raceway thermal analyses for temperature and sizing calculations
- ✓ Cable I^2t curve for protective device coordination
- ✓ Cable pulling analyses for tensions and sidewall pressure calculations

With ETAP, you can model, design, analyze, and optimize your electrical systems. This integration of data provides consistency throughout the project and eliminates repetitive data entry for the same element. This in turn reduces the time required to model and analyze a power system in its entirety, which results in time and cost savings.

Analysis Capabilities

ETAP PowerStation 4.7 is a major upgrade to ETAP PowerStation 4.0.4. The analysis capabilities available to you will depend on the configuration of modules purchased.

Cable Pulling NEW MODULE

- 3-D isometric view
- Pull multiple cables with different sizes
- Create straight segments & bends in any direction
- Checks for NEC requirements
- Forward & reverse tensions including sidewall pressures
- Includes Crystal Reports® & Microsoft Access® output databases

Motor Parameter Estimation NEW MODULE

- Estimate dynamic parameters of induction machines
- Include parameter variations due to speed and/or deep-bar effects
- Requires most readily-available characteristics published by manufacturers
- Calculate input parameters using estimated results & report any deviations

Transformer MVA Sizing NEW MODULE

- Sizing based on the actual connected or operating load
- Includes ANSI & IEC standard types, classes, & ratings



- Considers ambient temperature, altitude, load growth, diversity factors, etc.

Transformer Tap Optimization NEW MODULE

- IEEE CSF.116 Standard
- Optimizes transformer's tap setting and/or turns ratio
- Considers transformer's primary & secondary side feeders
- Considers system voltage variation, connected generation, & auxiliary loads
- Plots generator Mvar output vs. system voltage

Load Flow

- Unbalanced load flow calculations for panel systems & single-phase networks
- Alert view for panel systems & single-phase networks
- Voltage drop calculation for panel systems & single-phase networks
- Added an option to display load terminal voltages using Load Rated kV or Bus Nominal kV
- Enhanced Equipment Cable Losses Summary Report
- Added option to display bus angles

Short-Circuit

- Graphical plots of transient short circuit currents (IEC 363)
- Generator circuit breaker interrupting duty calculation (ANSI C37.010 – 1999)
- User-definable contact parting time & time constant for HV circuit breakers
- Ith & Ik calculations (IEC 909)
- Expanded arc duration range for Arc Flash Hazard calculations

Motor Acceleration

- New plots & graphical display of power flows for MOVs, generators, & power grids
- New enhanced plots of accelerating motors
- Added an option to display load terminal voltage based on Load Rated kV or Bus Nominal kV

Transient Stability

- Expanded Crystal Reports®
- Expanded calculations to handle frequency-dependent models for induction machines
- Expanded calculations to handle non-windup limiters for exciter types ST2 and ST3 models

User-Defined Dynamic Models

- Enhanced control blocks for exciter, governor, & stabilizer circuits
- Enhanced library of pre-configured models

Optimal Power Flow

- Crystal Reports® & Microsoft Access output databases

Reliability Assessment

- Enhanced program to handle double contingency or multi-stage failure analyses



Protective Device Coordination

- Motor Operated Valves (MOV)
- Expanded Device Library

Underground Cable Raceway Systems

- Conductor temperature calculations (IEC 287)
- Includes Crystal Reports® & Microsoft Access output databases
- Added automatic scrolling for UGS graphics
- Enhanced armor options & includes wire quantities up to 9999
- Enhanced Neher-McGrath to utilize various β angles for armor

Ground Grid Systems

- Enhanced printing functions
- Added calculation progress window
- Boundary extension limitation is increased from 3 ft/m to 99 ft/m
- Enhanced program to handle zero surface material for IEEE 80 and IEEE 65

Generator Fuel Cost

- Incremental cost curves
- Generator heat rate curves
- User-defined fuel cost profiles

One-Line Diagram

- Display of load flow results for single-phase networks
- Display of unbalanced three-phase load flow results for Panel Systems
- Wheel-mouse compatible panning/auto-scrolling
- Drag and drop between the one-line diagrams, composite networks, and Dumpster
- Long output report names (64 characters)
- Detailed display of license information in the About ETAP dialog box

Data Exchange

- DXF export of ETAP project files including graphical annotations, results, etc.
- Enhanced database conversion/synchronizations from common database formats, CSV, XML, IEEE, GIS & most third party applications
- Enhanced XML export of ETAP project data including nested or flat layout of the one-line diagram
- One-click zip (compress) & e-mail an ETAP project with options to include reports and/or libraries
- XML - Duty cycles for DC elements are added to the XML file export

General

- USB key and serial printer port keys are available to license stand-alone copies
- Enhanced the Help/About PowerStation screen to include detailed license information for PowerStation keys
- PowerStation projects (MS Access database®) created with earlier versions of ETAP PowerStation are automatically converted to Microsoft® Access 2000 upon opening
- Output filename length is increased from 8 to 64 alphanumeric characters



- Manufacturer data is added to fuse, cable, battery, and harmonics libraries
- Phase connections are added for Motor Nameplate reports for the Schedule Manager

Real-Time Monitoring (PSMS)

- Enhanced ActiveX support for non-electrical measurements (such as temperature, pressure, etc.) for Man-Machine Interface (MMI)
- New Comparator View of the estimated voltages & flows vs. real-time data

Real-Time Simulation (PSMS)

- Predict real-time system response based on remote power generator control signals
- New Comparator View of the simulated load flow results vs. real-time data

Operating Systems & Software Requirements

Microsoft Windows with Internet Explorer 5.0 or higher

- 98 (Second Edition)
- NT 4.0 (Service Pack 6 or higher)
- 2000 (Service Pack 2 or higher)
- Me
- XP (Home or Professional)

Minimum PC Requirements

- Intel Pentium II
- 128 MB of RAM
- 500 MB available hard drive space
- 1024x768 resolution
- Parallel Port
- Optional - USB Port (stand-alone licensing only)
- Optional - Serial Port (stand-alone licensing only)

Recommended PC Configuration

- Intel Pentium IV or higher
- 512 MB of RAM
- 2 GB available hard drive space
- 21" monitor with 1024x768 resolution
- Internet Explorer 5.0 or higher
- Parallel Port
- Optional - USB Port (stand-alone licensing only)
- Optional - Serial Port (stand-alone licensing only)
- Microsoft Windows 2000 Professional or XP Professional



ETAP PowerStation 4.0.4

April 2002

ETAP PowerStation is the most sophisticated engineering power system analysis tool on the market today. Thousands of hours of design and engineering experience have gone into the overall development of this software. We have combined state-of-the-art software development experience with real-life, practical engineering know-how to create an intelligent, yet user-friendly, engineering software.

Analysis Capabilities

ETAP PowerStation 4.0.4 is a minor upgrade to ETAP PowerStation 4.0.0. The analysis capabilities available to you will depend on the configuration of modules purchased.

Load Flow

- New double-precision Newton-Raphson method with current injection
- Phase-shifting transformer
- New summary output report on bus loadings and overload conditions
- New Alert View to display critical and marginal limit violations

Short-Circuit

- CB Duty calculation based on the maximum-through fault current (ANSI)
- Phase-shifting transformer for ANSI unbalanced faults
- New Alert View to display critical and marginal limit violations
- New Arc Flash analysis program for determining incident energy and flash protective boundary (ANSI and IEC)

Harmonics

- Filter Overloading
- I*T Index
- Phase-shifting transformer
- Customizable output reports using Crystal™ Reports format

Transient Stability

- Synchronous motor exciter/AVR system
- Automatic CB operation based on instantaneous relay settings
 - ✓ Overcurrent (50/50G)
 - ✓ Directional Overcurrent (67)
 - ✓ Reverse Power (32)
 - ✓ Motor Overcurrent (50M)
 - ✓ Solid State Trip (SST)
- Loss of excitation action
- New plots for machine terminal impedance (for out-of-step relay setting)
- New plots for branch flows (MW, Mvar, MVA, and Amps)
- IEEE models for Power System Stabilizers (PSS)
- New manufacture models for exciters and governors



- User-defined Dynamic Models (UDM) interface for:
 - ✓ Exciter/AVR
 - ✓ Governor - Turbine
 - ✓ Power System Stabilizer
- Complete integration with UDM for the Generator Start-Up program
- Phase-shifting transformer
- Segment (fractional) faults for cables and transmission lines
- Remote voltage control bus for all exciters

Libraries

- Reliability Index Library
- Interruption Cost Library
- Expanded existing library data

Reliability Assessment Analysis – NEW MODULE

- Analysis includes protective device effects on fault isolation and load restoration such as replacement and alternative supply
- Radial, looped, and multiple isolated system configurations
- Model each component with its own reliability characteristics
- Implements the user-defined parameters and settings
- Calculate load point and bus reliability indices:
 - ✓ Average Failure Rate [λ]
 - ✓ Average Outage Duration [r]
 - ✓ Annual Outage Duration [μ]
- Calculate system reliability indices:
 - ✓ System Average Interruption Frequency Index [SAIFI]
 - ✓ System Average Interruption Duration Index [SAIDI]
 - ✓ Customer Average Interruption Duration Index [CAIDI]
 - ✓ Average Service Availability Index [ASAI]
 - ✓ Average Service Unavailability Index [ASUI]
- Calculate reliability cost/worth indices for load points, buses, and system:
 - ✓ Expected Energy Not Supplied [EENS]
 - ✓ Expected Interruption Cost [ECOST]
 - ✓ Interrupted Energy Assessment Rate [IEAR]
- Rank element contributions to the cost/worth indices
- Sensitivity analyses for EENS's and ECOST's:
 - ✓ Element contributions to the EENS and their rankings
 - ✓ Element contributions to the ECOST and their rankings
- Customizable output reports using Crystal Reports format

Cable Ampacity

- ICEA P-55-440 cable tray ampacity calculator (Stolpe Method)

User-Defined Dynamic Models (UDM) – NEW MODULE

- Build your own governor/turbine, exciter/AVR, and Power System Stabilizer control block diagrams for Transient Stability analysis
- Large selection of control blocks and elementary functions



- Stand-alone test model performance including isolated step response
- Complete integration with Generator Start-Up analysis
- Run-time compile within ETAP PowerStation
- Utilize models within the Transient Stability Program
- Select user-built models within generator editors
- Utilizes block diagrams generated by Simulink®
- Implement system-wide operations such as load shedding, fast bus transfer, islanding, etc.

Motor Starting

- Phase-shifting transformer

Ground Grid Systems – NEW MODULE

- Analysis includes four different methods
 - ✓ IEEE 80 - 1986
 - ✓ IEEE 80 – 2000
 - ✓ IEEE 665 – 1995
 - ✓ Finite Element
- Graphic user interface for conductors and rods
- Graphic Soil View
- Handles irregular configurations of any shape
- Allows a two-layer soil model in addition to the surface material
- Unlimited conductors and rods
- Conductor segments can be oriented in any possible 3-D direction
- Complete integration with one-line diagram for elements placed on the grid and short-circuit values
- Calculates tolerable step and touch potentials
- Compares calculated step and touch potentials with tolerable limits
- Optimizes number of conductors with fixed rods
- Optimizes number of conductors and rods based on cost
- Calculate the maximum allowable current for conductors
- Compares allowable currents against fault currents
- Calculates ground system resistance
- Calculates ground potential rise (GPR)
- User-expandable conductor library
- Tabulates absolute, step, and touch potentials throughout the grid
- 3-D plot of grid configuration showing conductors and rods
- 3-D plots of absolute, step, and touch potentials
- Customizable output reports using Crystal Reports format

Battery Discharge Analysis – NEW MODULE

- Calculate battery discharge using an existing battery or using a battery that is automatically sized by ETAP
- Battery discharge using DC Load Flow method or load summation method
- Generate plots and reports using Crystal Reports
- Use different diversity and correction factors such as, temperature, aging, initial capacity, and initial conditions
- Plots for battery duty cycle, voltage, capacity, current, power and characteristics
- Plots for branch flow, bus voltage, and bus loading



Optimal Power Flow

- Generator fuel cost minimization
- Utility electricity cost minimization

Panel Systems – NEW MODULE

- 3-phase 3-wire and 4-wire panels
- 1-phase 2-wire and 3-wire panels
- Graphic user interface
- Unlimited circuits with or without external connections
- Unlimited sub-panel connections
- External (graphical) load and branch connections
- Spreadsheet load modeling
- Column and standard layouts
- ANSI and IEC standard panels
- Extensive switching device libraries
- Comprehensive circuit feeder/cable libraries
- User-configurable defaults and layouts
- Dynamic sub-panel and main-panel schedule updates
- User selectable load types (LCL, NCL, warehouse, receptacle, hospitals, etc.)
- User modifiable demand and diversity factors (NEC and others)
- Ten loading categories per circuit
- Customizable panel schedules using Crystal Reports format
- Intelligent panel calculations
- Detailed panel loading summary

One-Line Diagrams

- Single-Phase System (2 and 3 wires)
- Remote Connector
- Panel Systems
- Phase Adapter
- Ground Grid Systems
- New Relays
- Active X (Programmable Objects)
- XML Data Exchange