

# Arc Flash Analysis Done Right

Part 1 – System Modeling & Studies for Existing Systems



# What is Arc Flash?

- Result of rapid release of energy due to an arcing fault between two conductors.
- Bus voltages  $> 208V$
- Temperatures as high as  $36,000\text{ }^{\circ}F$

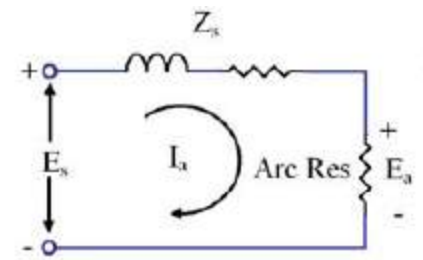
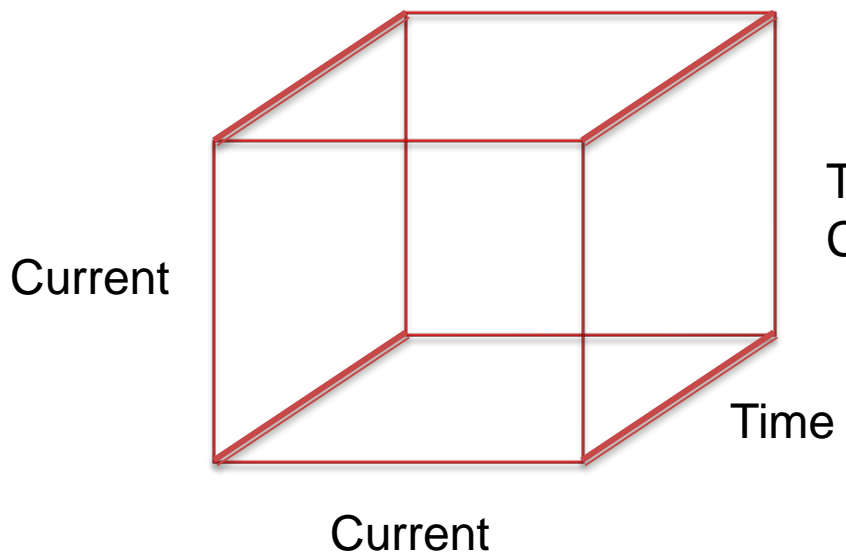



# Arc Flash Hazard

- Intense Heat
- Thermo-acoustic shock wave
- Molten metal
- Shrapnel
- Blinding light
- Toxic smoke
- Contact with energized components



# Why Arc Flash Now?

- Arc Flash prevention is at the forefront:
  - Greater understanding of arc flash hazards and the risks they pose to personnel
  - Increased enforcement on the part of OSHA to judge whether the employer “acted reasonably” in protecting its workers from arc flash hazards



# Arc Flash Standards

- IEEE 1584-2002
- IEEE 1584a-2004
- IEEE 1584b-2009(?) – In Ballot
- IEEE 1584.1 – In Progress
- IEEE 3002.5 – In Progress
- NFPA 70E-2009



# Safety Standards

- OSHA regulations were developed to mandate that employers provide a safe workplace for their employees
- CFR Part 1910 promotes the safety of employees working on or near electrical equipment and clearly defines employer responsibilities



# Employer Responsibilities

- Equipment must be de-energized before work is performed unless demonstrated:
  - De-energizing introduces additional or increased hazards
  - Infeasible due to equipment design or operational limits
- Lockout / Tag out (LOTO) procedures must be used



# Employer Responsibilities

- If equipment cannot be de-energized prior to work:
  - Employees must be properly protected
  - Employers are responsible for performing a hazard assessment

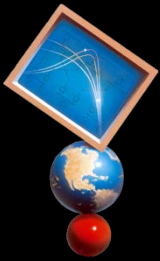

# Conveying the Hazard

- Arc Flash information needs to be determined and documented
- Protection boundaries established and appropriate PPE must be provided
- Panels and electrical equipment must be labeled:
  - Labels are the end product but a number of prerequisite steps must be followed
  - Arc flash calculations is one of the steps of the entire arc flash assessment



# Qualifications of Study Engineer

- Arc flash calculations should be performed by or under the direction of a qualified person with experience in performing power system studies including arc flash calculations
- Have familiarity with the industry for which the study is being performed

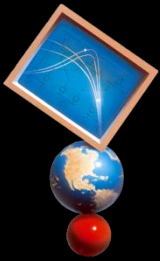

# Calculation Methodology

- Utilize IEEE 1584 – Guide for Performing Arc Flash Calculations
- NFPA 70E table approach is not needed.
- Avoid using quick calculators except for approximate calculations
- 3-Phase equations can be used for 1-Phase system with conservative results.
- Empirical equations can be used where IEEE equations do not apply. ( $>15$  kV or  $< 208$  V)

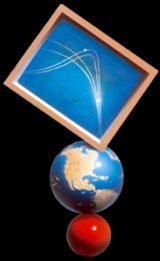

# Arc Flash Study Prerequisites

- Scope of study
- Field verification and audit
- Update one-line diagrams
- Software modeling and design
- Short-circuit analysis
- Protective device coordination



# Scope of Arc Flash Study

- Scope and level of detail depend upon complexity of the system:
  - Simple System – Begin at point of electrical service. e.g. office buildings, commercial facilities, small industrial and institutional systems
  - Intermediate System – Customer owned service transformer and/or secondary selective substation. e.g. mid sized industrial, institutional and large commercial facilities



# Scope of Arc Flash Hazard Study

- Scope and level of detail depend upon complexity of the system:
  - Complex System – System includes nominal voltage  $> 600$  V, protective relaying, network systems, customer owned primary substation, customer owned generation for prime power. e.g. large industrial complexes, campus type systems with multiple modes of operations



# Scope of Arc Flash Hazard Study

- Encompass all equipment from customer owned service entrance down through major equipment rated 208V nominal
- Equipment rated  $< 240$  V served by transformer rated  $\leq 125$  kVA may be excluded

Hazard Cat for LV Equipment

Voltage  $\leq$   Xfmr  $\leq$   kVA

Cat 0  Ibf  $\leq$   kA

Cat 1  Ibf  $\leq$   kA

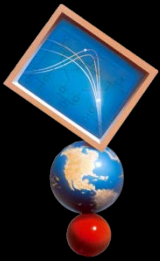

# Field Verification and Audit

- Most critical step for all system studies
- Become familiar with plant layout, equipment and maintenance procedures
- Walk-downs to validate drawings and access equipment condition
  - Start with most recent / accurate one-line diagram. Highlight or mark-off each piece of equipment on the one-line:
    - Connectivity
    - Cable/Line lengths
    - Nameplate ratings
    - Protective device locations and settings
  - Work with electricians to gather and document data



# Field Verification and Audit

- Take pictures during field verification



Adobe Acrobat Document



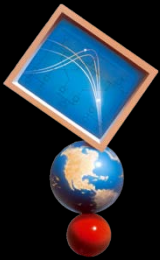

# Field Verification and Audit

- Generate / update worksheets with protective device information & settings.
- What is missing in this settings sheet?

50/51	CO	SUB 8	TIME O.C.	TAP:6 T.D.:9 INST 180 A.	ABB	1200/5
50/51	CO	SUB 8	TIME O.C.	TAP:6 T.D.:9 INST: 180 A.	ABB	1200/5
50/51	CO	SUB 8	TIME O.C.	TAP:6 T.D.:9 INST: 180 A.	ABB	1200/5

- Curve Type



# Field Verification and Audit

- Validate main feeder lengths
- Issue mark-ups to update CAD drawings as needed
- Wear PPE based on NFPA tables when collecting data for equipment with no labels
- At higher voltages rely on HV qualified electricians to collect data
- Equipment ID's in the electrical model must match the system device ID / tag number



# Summary of Field Verification

Equipment	Count (From Client)	Count (After Field Verification)
Bus	337	339
Cable	608	1292
HVCB	76	84
LVCB	451	1205
Contactactor	485	1169
Fuse	219	220
Induction Motor	461	1143
OCR	466	474
CT	413	424

- Above example shows missing equipment added to existing model after field verification such as LV motors > 50 HP and load equipment feeders
- Data collection must have high precision for arc flash studies for higher accuracy
- Other studies like short circuit may not need high precision data collection since they tend to be on the conservative side



# Data Collection

- Utility Normal, Max and Min SC Rating
  - Contact utility for most recent values
  - Max and Min SC rating for Coordination
- Working Distances
  - IEEE 1584 –Table 3, however alternate working distances to be used as applicable.
- Equipment Type and Condition
  - MCC, Switchgear, etc. (Isolated / Not Isolated)
  - Evaluate age, condition and maintenance history
  - Poorly maintained equipment may not operate

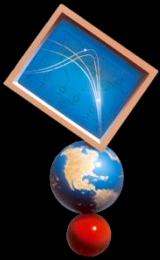

# Sample Data Collection Sheet

BREAKER IDENTIFICATION	BREAKER TYPE	FRAME SIZE	TRIP UNIT	TRIP UNIT#	PLUG #	In	SENSOR RATING	LTPU	LONG DELAY	STPU	SHORT DELAY	INST.	NOTES & REMARKS	LAST CAL
MAIN 480V SWGR	CH DSII-632	3200	DIGITRIP RMS 510		3000A	3200A	3200A	1.0	2.0	2.0	0.3	DIS		10/12/2006

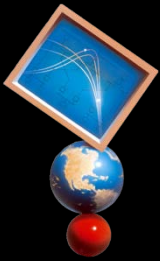

# Data Assumptions

- When relay, circuit breaker and fuse data not available – no assumption should be made to their type, style, setting or clearing time.
- Arc Flash analysis should not be performed on downstream devices with assumed data.
- If you must provide result, select the further upstream device that has known data and calculate results based on that device.



# Example

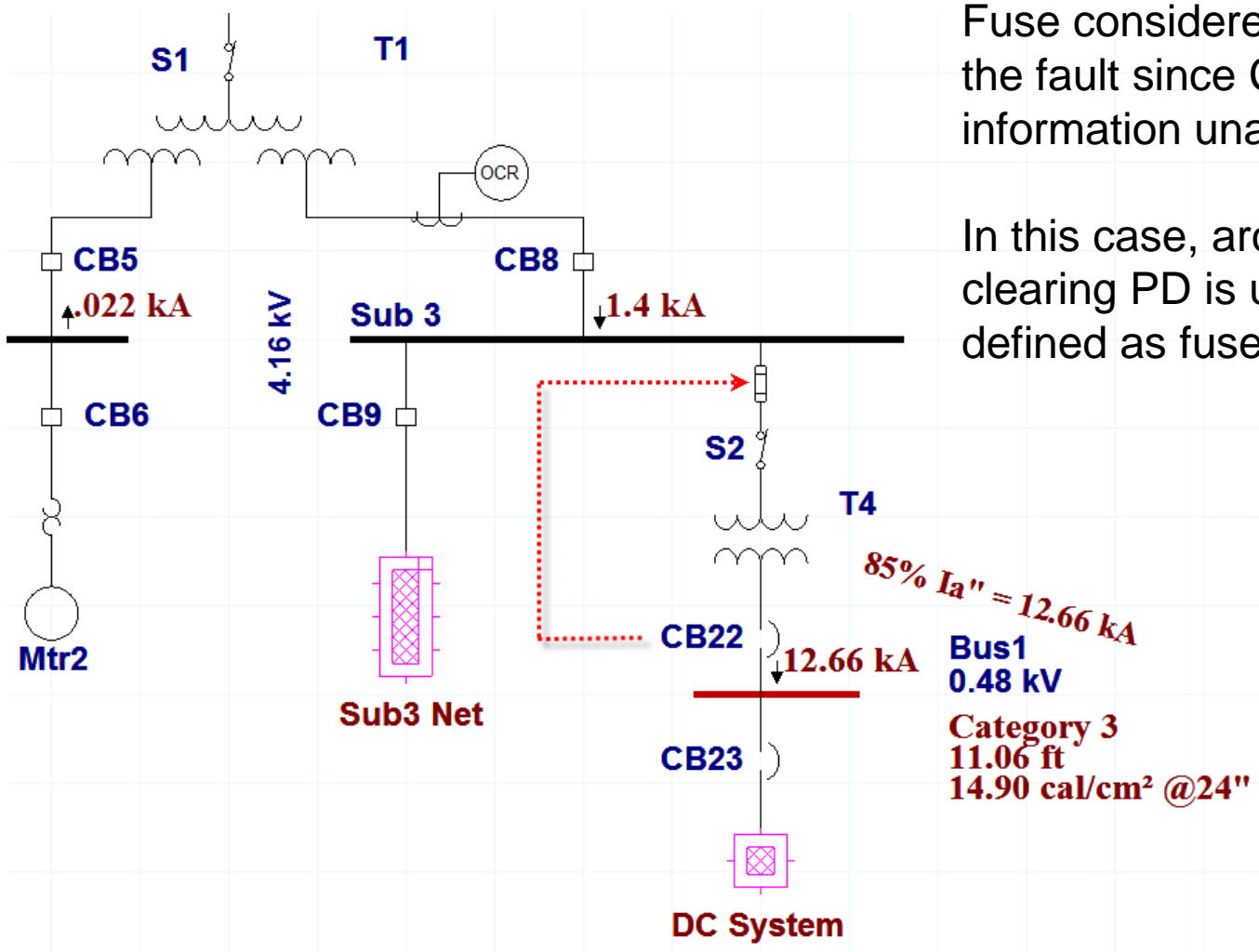

Fuse considered to clear the fault since CB22 information unavailable.

In this case, arc fault clearing PD is user-defined as fuse

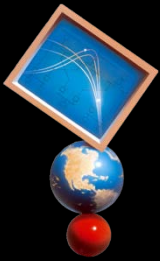

# Short Circuit Analysis

- Short circuit model provides accurate representation of system Z.
- Arc flash study should be based on up-to-date short circuit study that reflects existing conditions, system configurations and operating scenarios.
- Maximum fault levels calculated.
- Identify device duty problems prior to proceeding with arc flash calculations.

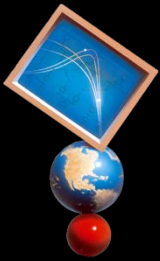

# Short Circuit Analysis

- System representation should include accurate momentary, interrupting and steady state fault currents.
  - Neglecting steady state currents may give inaccurate picture of how devices will operate. This becomes an important factor for systems with generation.
  - Incident energy decay is directly proportional to decay in short circuit current.



# Fault Current Decay

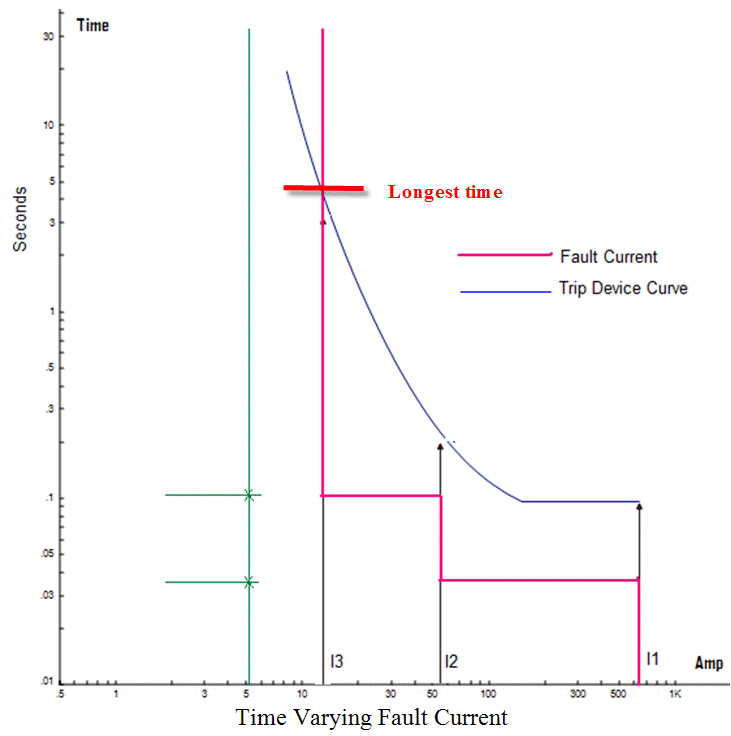
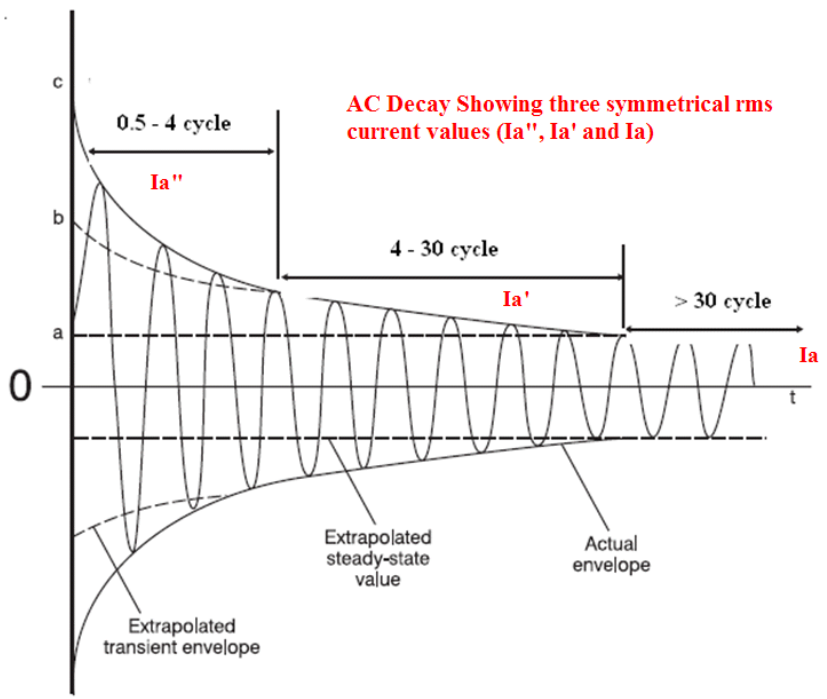

$$\int_0^{T_0} \frac{1}{t(I)} dt = 1$$

IEEE Std C37.112-1196 equation (3)



# Fault Current Recording

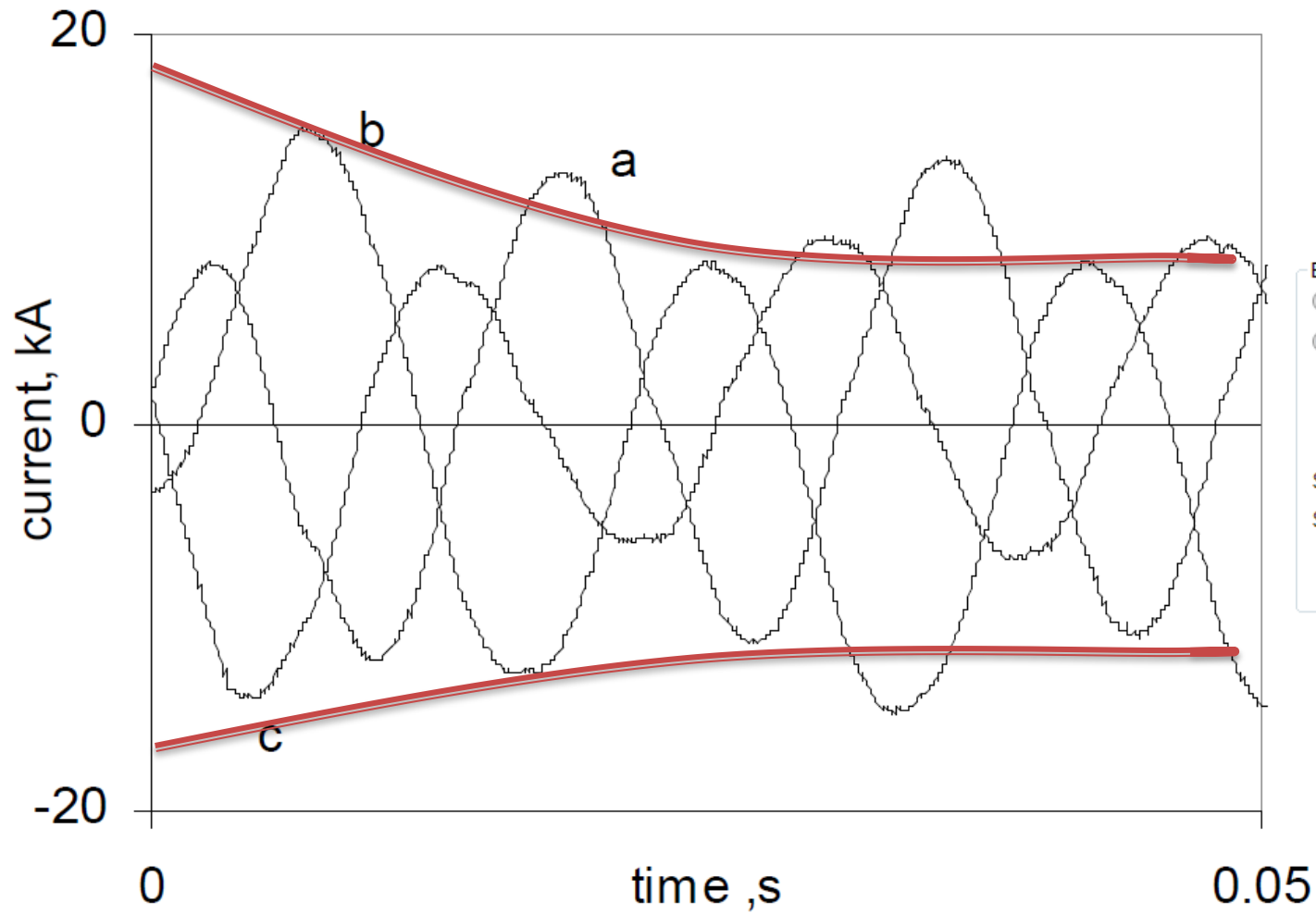

Bus Fault Current

- User-Defined (Bus Editor)
- Calculate
  - 3-Phase
  - 1-Phase
- Symm. 1/2 Cycle
- Symm. 1.5 to 4 Cycle
- Fault Current Decay

Steady-State Ibf at  Cycles

Syn. Gen Steady-State Ibf

- Limit Gen Ibf to  %FLA
- Determine from Decrement Curve

Arcing Currents at 208V, 9.9kA



# Fault Current Decay-MV System

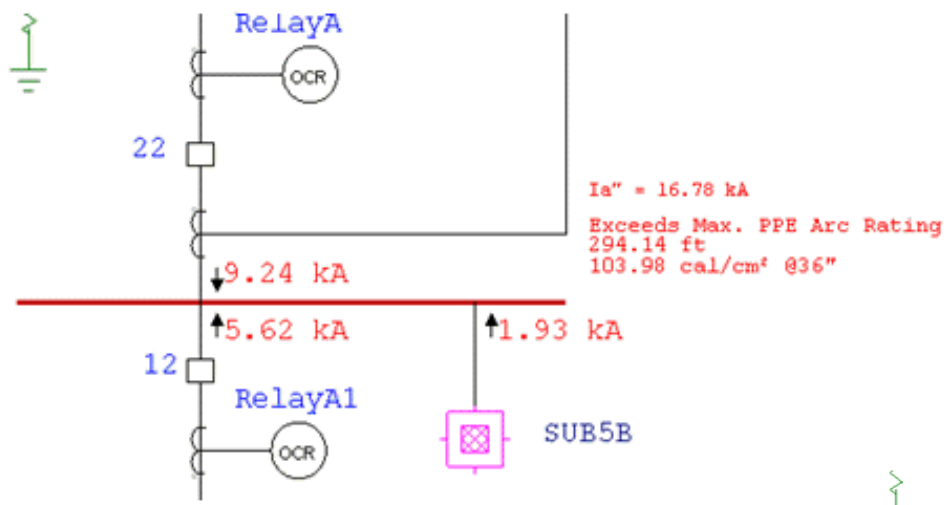

Fault Current Decay Method

## 1/2 Cycle Method

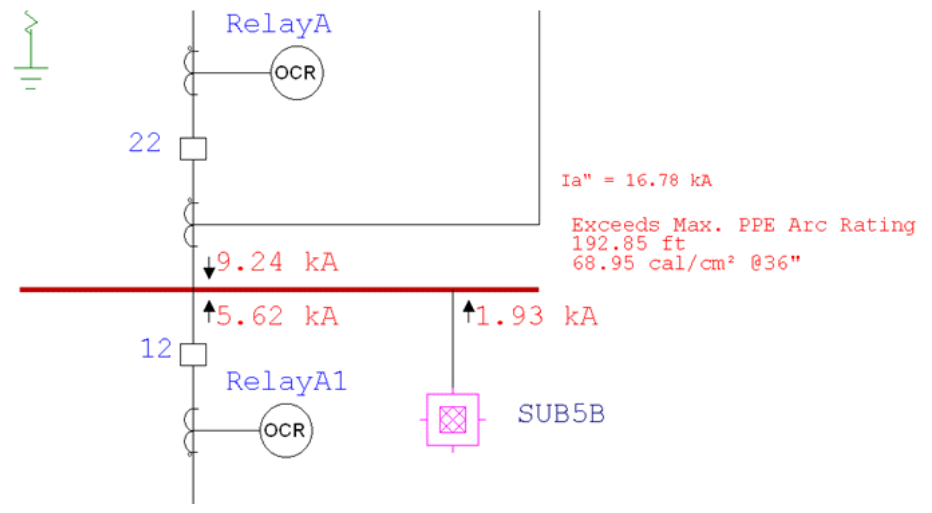

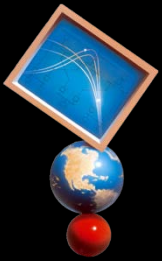

# Protective Device Coordination

- Existing device ratings and settings must be field verified
- Identify any mis-coordination based on bolted fault
- Include protection schemes utilized in the system such as differential and directional relays
- Plot arcing current to compare against device ST and INST settings
  - LV Arcing Fault ~ 38% of Bolted Fault
  - MV Arcing Fault ~ 90% of Bolted Fault



# Protective Device Coordination

- Ensure that downstream device (breakers / fuses) clear the short circuit fault.
- For selective coordination, sufficient time separation between devices must be maintained.
- Consider relay calibration state and age when determining operating time.



# Relay Calibration

- Latest relay test reports
- Advanced Relay Test & Transient Simulator [Click here for more details](#)

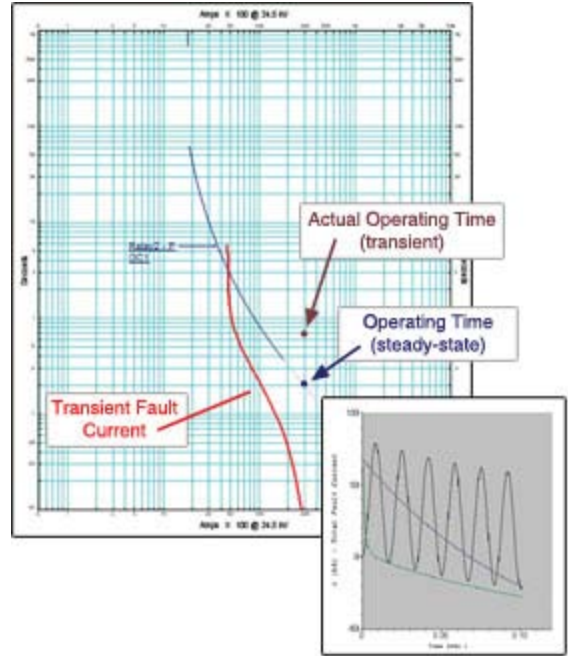
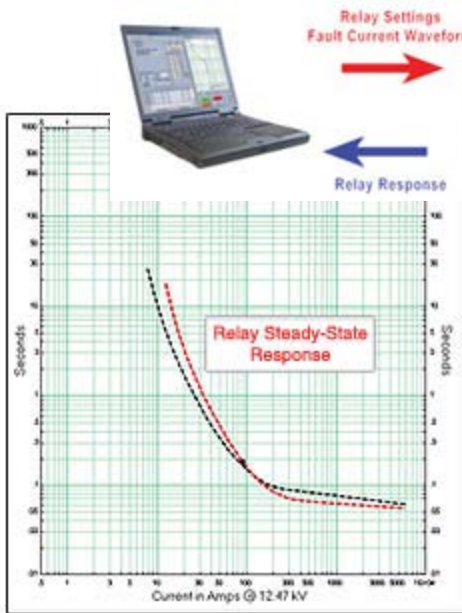



# Arc Flash Study Options

- Prefault Voltage = System Nominal kV
- Faulted buses include SWGR, MCC, Panelboards, etc.
- Consider decaying and non-decaying fault currents
- Include motor equipment cables and overload heaters

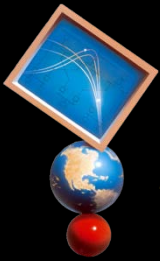

# Arc Flash Study

- Consider various utility MVA<sub>sc</sub>
- Consider combinations of secondary selective tie breaker open / close
- Consider combinations of sources in and out of service
- Determine Arc Thermal Performance Value (ATPV) / EB<sub>T</sub> rating for equipment (cal/cm<sup>2</sup>)



# Arc Flash Study

- Panelboard / MCC / Switchboard
  - Typically main source PD may not be isolated
  - Evaluation of equipment must be made
  - More conservative results may be needed i.e. use next upstream protective device to determine results

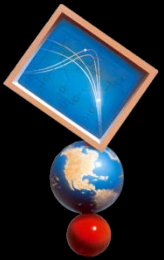

# Example

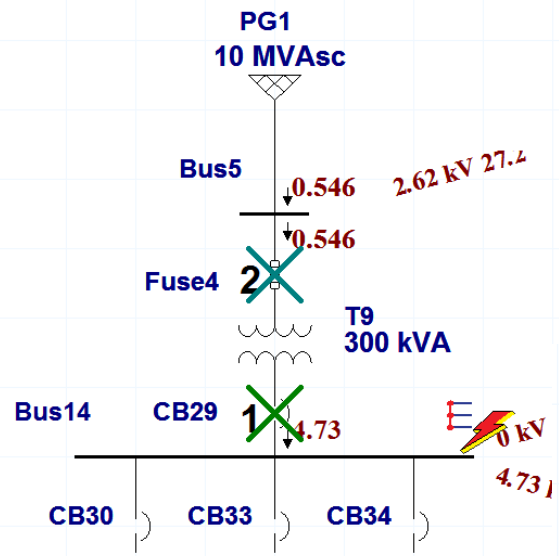

Bolted Fault Coordination

MCC Main Breaker not isolated

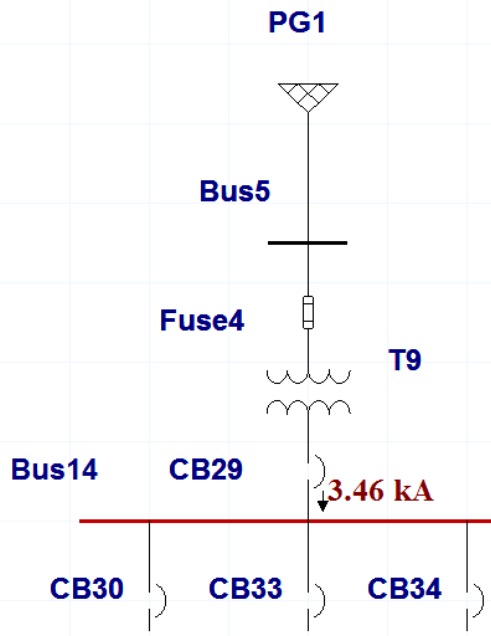

Category 0  
1.01 ft  
0.63 cal/cm<sup>2</sup> @18"  
Ia'' = 3.46 kA

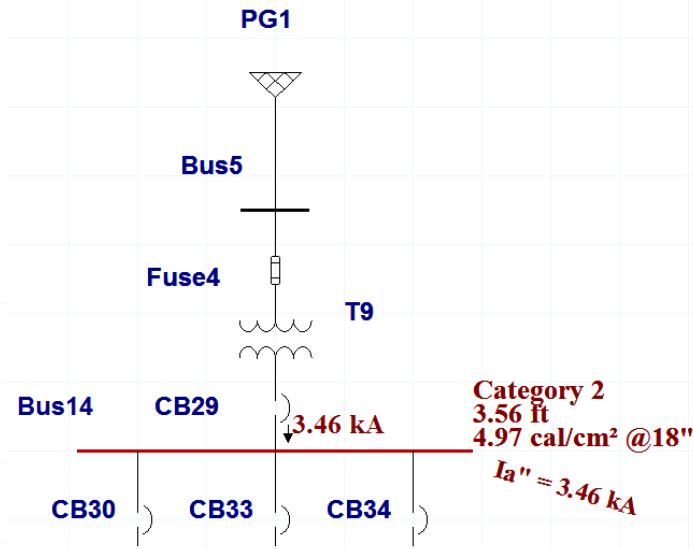

Using upstream PD Fuse 4  
Category 2  
3.56 ft  
4.97 cal/cm<sup>2</sup> @18"  
Ia'' = 3.46 kA

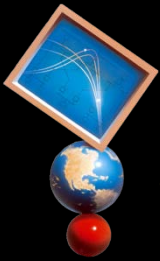

# Arc Flash Study – Low Voltage

- IEEE 1584 tests showed one case of sustained arc at 208 V ( $> 10$  kA with 12.7 mm gap) in enclosure without barrier.
  - Phase conductors with open tips
  - Real-world equipment has insulating barriers
- Effect of Insulating Barriers in Arc Flash Testing (Sept 2008)
  - Self sustaining arcs possible at 208V with 12.7 mm gap with 4.5 kA



# Arc Flash Analyzer

- Compare all cases to determine worst case arc flash incident energy
- Utilize ETAP arc flash result analyzer to determine worst case.



# Arc Flash Analyzer

**Arc Flash Report Analyzer**

Output Report    Scenarios

Ref.	Select	Reports
<input checked="" type="radio"/>	<input checked="" type="checkbox"/>	AF-Decay
<input type="radio"/>	<input checked="" type="checkbox"/>	AF-HalfCycle
<input type="radio"/>	<input checked="" type="checkbox"/>	ANSI-Duty

Project Report

All Project in Active Directory  
 Active Project

Example-ANSI

Bus  
 Protective Device  
 Load Terminals

Info

kV  
 Type  
 Connected Bus  
 Bus Gap (mm)  
 X Factor  
 Grounding

ID	kV	AF-Decay	AF-HalfCycle	ANSI-Duty
Bus1	0.48	5.7	5.7	5.7
Bus2	0.48	1.6	1.6	1.6
Bus14				5
Bus23A	0.48			
LVBUS	0.48	171.8	209.1	189.1
Main Bus	34.5	8004.5	1395.7	1384.1
MCC1	0.48	1.5	1.5	1.4
Sub2A	13.8	4.2	4.3	4.2
Sub2B	13.8			
Sub 3	4.16	13.7	13.9	13.7
Sub3 Swgr	4.16	6.4	6.5	6.4
Sub22	3.45	5.6	6.2	5.5
Sub23	3.45			

Copy   Sort

Filter Results By

Incident Energy  
 FCT Not Determined  
 % Ia Variation  
 FCT by Secondary PD  
 Exceeds Max. FCT

Filter Reports By Hazard Category

NFPA 70E 2009

	cal/cm <sup>2</sup>	
<input checked="" type="checkbox"/> Cat 0	1.2	
<input checked="" type="checkbox"/> Cat 1	4	
<input checked="" type="checkbox"/> Cat 2	8	
<input checked="" type="checkbox"/> Cat 3	25	
<input checked="" type="checkbox"/> Cat 4	40	

Show Colors

Display Options

Actual Value  
 Differences with Ref.  
 Skip If Same

FCT Unit

Cycles

Reporting

Standard Label   Custom Label  
Work Permit   Data Sheet

Export...   Find   Help   Close



# Arc Flash Analyzer

**Arc Flash Report Analyzer**

Output Report | Scenarios

Ref.	Select	Reports
	<input checked="" type="checkbox"/>	AF-Decay
	<input checked="" type="checkbox"/>	AF-HalfCycle
	<input checked="" type="checkbox"/>	ANSI-Duty

Project Report

All Project in Active Directory

Active Project

Example-ANSI

Bus

Protective Device

Load Terminals

Info

kV

Type

Connected Bus

Bus Gap (mm)

X Factor

Grounding

Results

Total Energy (cal/cm<sup>2</sup>)

Energy 1 (cal/cm<sup>2</sup>)

Energy 2 (cal/cm<sup>2</sup>)

Energy 3 (cal/cm<sup>2</sup>)

PPE Description

FPB

Hazard Category

Final FCT

Ia at FCT (kA)

ID	kV	Output Rpt.	Configuration	Total Energy	FPB (ft)	Hazard Category	Final FCT	Source PD ID	% Ia Variation
Bus1	0.48	AF-HalfCycle	Normal	5.7	5.7	Cat 2	10.5	CB22	
Bus2	0.48	AF-HalfCycle	Normal	1.6	1.8	Cat 1	3.6	CB31	
Bus14	0.48	ANSI-Duty	Normal	5	3.6	Cat 2	28.3	Fuse4	
LVBus	0.48	AF-HalfCycle	Normal	209.1	34.8	> Cat 4	342.1	CB8	15%
Main Bus	34.5	AF-Decay	Normal	8004.5	245.5	> Cat 4	1087.3	CB10	
MCC1	0.48	AF-HalfCycle	Normal	1.5	1.7	Cat 1	3	Fuse3	15%
Sub2A	13.8	AF-HalfCycle	Normal	4.3	5.6	Cat 2	13.1	CB11	
Sub 3	4.16	AF-HalfCycle	Normal	13.9	18.6	Cat 3	13.9	CB8	
Sub3 Swgr	4.16	AF-HalfCycle	Normal	6.5	17.1	Cat 2	13.9	CB8	
Sub22	3.45	AF-HalfCycle	Normal	6.2	16.1	Cat 2	30.7	CB12	

Copy | Sort

Filter Results By

Incident Energy  Max  Min

FCT Not Determined

% Ia Variation

FCT by Secondary PD

Exceeds Max. FCT

Filter Reports By Hazard Category

NFPA 70E 2009

	cal/cm <sup>2</sup>	
<input checked="" type="checkbox"/> Cat 0	1.2	
<input checked="" type="checkbox"/> Cat 1	4	
<input checked="" type="checkbox"/> Cat 2	8	
<input checked="" type="checkbox"/> Cat 3	25	
<input checked="" type="checkbox"/> Cat 4	40	

Show Colors

Display Options

Actual Value

Differences with Ref.

Skip If Same

FCT Unit

Cycles

Reporting

Standard Label

Custom Label

Work Permit

Data Sheet

Export... Find Help Close



# Arc Flash Analysis Report

- Executive Summary
- Scope and summary of major findings
- Findings and recommendations
  - Short circuit analysis
  - Coordination study
  - Arc flash study
- Tabulate results listing equipment arc flash energy
  - Bolted fault current, arcing fault current, identify tripping device and clearing time, working distance, arc flash protection boundary, incident energy, hazard/risk category
  - Arc flash labels



# Arc Flash Mitigation

- De-energize whenever possible
- Reduce total amp-cycles of the arcing fault ( $I^2t$ )
  - Overcurrent device setting changes
  - Fuse size/type changes
  - Addition of new overcurrent protection for better selectivity
  - Maintenance mode switch
  - Zone selective interlocking
  - Retrofitting breakers with new trip units
  - Arc flash light detecting circuit breakers / relays (fiber optics)



# Arc Flash Mitigation

## Keep Distance!

- Increase working distance
  - Hot sticks
  - Robotic racking systems
  - Remote racking systems
- Reduce arc flash exposure
  - Arc resistant gear
  - Infrared (IR) windows
  - Insulated buses
  - Partial discharge systems





# Arc Flash Enhancements ETAP 7.1

- Custom arc flash label

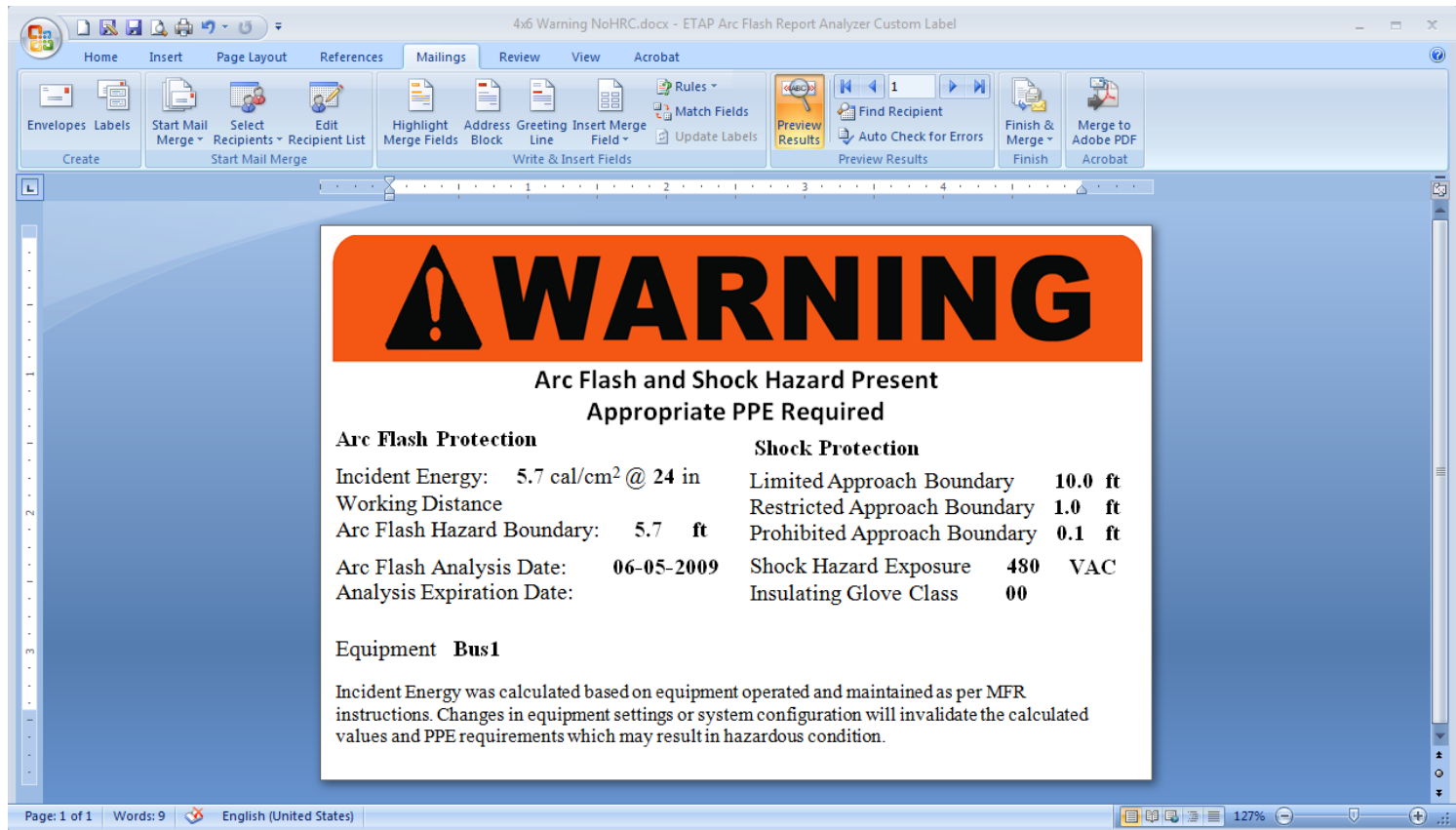



# Thank You

Next Southern California  
User Group Meeting  
March 23, 2010

Part 2  
Arc Flash Mitigation & Safety Program